

OWNER'S MANUAL
& REFERENCE



GPSMAP™
215/225



Software Version 2.12 or above

Internal Database Version 3.00 © 1998-2000 GARMIN Corporation

G-chart™ cartridge data is copyrighted and may not be copied or used for any other purpose without permission.

GARMIN Corporation, 1200 E. 151st Street, Olathe, KS 66062 USA

Tel: 913.397.8200

Fax: 913.397.8282

GARMIN (Europe) Ltd., Unit 5, The Quadrangle, Abbey Park, Romsey, Hampshire SO51 9AQ UK

Tel: 44/1794.519944

Fax: 44/1794.519222

Garmin (Asia) Corp., No. 68, Jangshu 2nd Rd., Shijr, Taipei County, Taiwan

Tel: 886/02.2642.8999

Fax: 886/02.2642.9099

Web Site Address: www.garmin.com

© Copyright 1998-2000 GARMIN Corporation All Rights Reserved

Except as expressly provided herein, no part of this manual may be reproduced, copied, transmitted, disseminated, downloaded or stored in any storage medium, for any purpose without the express prior written consent of GARMIN Corporation. GARMIN Corporation hereby grants permission to download a single copy of this manual and of any revision to this manual onto a hard drive or other electronic storage medium to be viewed and to print one copy of this manual or of any revision hereto, provided that such electronic or printed copy of this manual or revision must contain the complete text of this copyright notice and provided further that any unauthorized commercial distribution of this manual or any revision hereto is strictly prohibited. Information in this document is subject to change without notice. GARMIN reserves the right to change or improve their products and to make changes in the content without obligation to notify any person or organization of such changes.

GARMIN, GPSMAP 215, GPSMAP 225, AutoLocate, TracBack, MapSource, and PhaseTrac12 are all trademarks of GARMIN Corporation and may not be used without the expressed permission of GARMIN.



INTRODUCTION

Foreword

INTRODUCTION

Cautions

FCC Compliance

This device complies with Part 15 of the FCC limits for Class B digital devices. This equipment generates, uses, and can radiate radio frequency energy and, if not installed and used in accordance with the instructions, may cause harmful interference to radio communications.

There is no guarantee that interference will not occur in a particular installation. If this equipment does cause harmful interference to other equipment, which can be determined by turning the affected equipment off and on, the user is encouraged to try correcting the interference by relocating the equipment or connecting the equipment to a different circuit than the affected equipment. Consult an authorized dealer or service technician for additional help.

Operation is subject to the following: (1) This device cannot cause harmful interference, and (2) this device must accept any interference received, including interference that may cause undesired operation.



CAUTION: The Global Positioning System (GPS) is operated by the government of the United States, which is solely responsible for its accuracy and maintenance. The system is subject to changes which could affect the accuracy and performance of all GPS equipment. Although the GPSMAP is a precision electronic NAVigation AID (NAVAID), any NAVAID can be misused or misinterpreted and, therefore, become unsafe.

Use the GPSMAP at your own risk. To reduce the risk of unsafe operation, carefully review and understand all aspects of this Owner's Manual and thoroughly practice operation using the simulator mode prior to actual use. When in actual use, carefully compare indications from the GPSMAP to all available navigation sources including the information from other NAVAIDs, visual sightings, charts, etc. For safety, always resolve any discrepancies before continuing navigation.



WARNING: The electronic chart is an aid to navigation designed to facilitate the use of authorized government charts, not to replace them. Only official government charts and notices to mariners contain all information needed for the safety of navigation, and as always, the user is responsible for their prudent use.



CAUTION: The GPSMAP does not contain any user-serviceable parts. Repairs should only be made by an authorized GARMIN service center. Unauthorized repairs or modifications could void your warranty and your authority to operate this device under Part 15 FCC regulations.

GARMIN Corporation warrants this product to be free from defects in materials and manufacture for one year from the date of purchase. GARMIN will, at its sole option, repair or replace any components that fail in normal use. Such repairs or replacement will be made at no charge to the customer for parts or labor. The customer is, however, responsible for any transportation costs. This warranty does not cover failures due to abuse, misuse, accident or unauthorized alteration or repairs.

THE WARRANTIES AND REMEDIES CONTAINED HEREIN ARE EXCLUSIVE AND IN LIEU OF ALL OTHER WARRANTIES EXPRESS OR IMPLIED OR STATUTORY, INCLUDING ANY LIABILITY ARISING UNDER ANY WARRANTY OF MERCHANTABILITY OR FITNESS FOR A PARTICULAR PURPOSE, STATUTORY OR OTHERWISE. THIS WARRANTY GIVES YOU SPECIFIC LEGAL RIGHTS, WHICH MAY VARY FROM STATE TO STATE.

IN NO EVENT SHALL GARMIN BE LIABLE FOR ANY INCIDENTAL, SPECIAL, INDIRECT OR CONSEQUENTIAL DAMAGES, WHETHER RESULTING FROM THE USE, MISUSE, OR INABILITY TO USE THIS PRODUCT OR FROM DEFECTS IN THE PRODUCT. SOME STATES DO NOT ALLOW THE EXCLUSION OF INCIDENTAL OR CONSEQUENTIAL DAMAGES, SO THE ABOVE LIMITATIONS MAY NOT APPLY TO YOU.

To obtain warranty service, call the GARMIN Customer Service department (913-397-8200) for a returned merchandise tracking number or contact your GARMIN dealer. The unit should be securely packaged with the tracking number clearly marked on the outside of the package and sent freight prepaid and insured to a GARMIN warranty service station. A copy of the original sales receipt is required as the proof of purchase for warranty repairs. GARMIN retains the exclusive right to repair or replace the unit or software or offer a full refund of the purchase price at its sole discretion. SUCH REMEDY SHALL BE YOUR SOLE AND EXCLUSIVE REMEDY FOR ANY BREACH OF WARRANTY.

Serial Number

Use the area below to record the serial number (8-digit number located on the back of the unit) in case it is lost, stolen, or needs service. Be sure to keep your original sales receipt in a safe place or attach a photocopy inside the manual.

* *

INTRODUCTION

Limited Warranty & Registration

Registration

Help us better support you by completing our on-line registration today! Have the serial number of your GPSMAP 215/225 handy and connect to our website at (www.garmin.com). Look for the Product Registration link on the Home page.

Why should you register your GPSMAP 215/225?

- Notification of Product Updates
- Notification of New Products
- Lost or Stolen unit tracking

NOTE: If you have previously registered your GARMIN product purchase using a mail-in registration card, we invite you to re-register using our NEW on-line system. Many services provided by our new product registration system are now being automated and re-registering your purchase ensures you the best possible support from GARMIN.

INTRODUCTION

Packing List



The following optional accessories are available for your GPSMAP system:

- G-chart Electronic Chart Cartridges
- 110/220 Volt AC Adapter
- Flush Mounting Kit
- Cigarette Lighter Adapter
- MapSource™ PC Software
- PC Interface Cable
- GA23 H-Field DGPS Antenna
- GBR 21/23 DGPS Receivers
- Antenna Extension Cable
- Second Mounting Station
- Protective Cover

Congratulations on choosing one of the most advanced marine navigation systems available! The GARMIN GPSMAP navigators combine the proven performance of GARMIN PhaseTrac12™ GPS, built-in “basemap” cartography and powerful G-Chart™ electronic charting for detailed cartography wherever you cruise.

To get the most out of your new GPS navigation system, take the time to read through this owner's manual and learn the operating procedures for your unit. This manual covers the following GPSMAP units:

GPSMAP 215 3-gray level LCD chart plotter with built-in GPS (available with or without built-in DGPS beacon receiver)

GPSMAP 225 color LCD chart plotter with built-in GPS (available with or without built-in DGPS beacon receiver)

Before installing and getting started with your unit, please check to see that your package includes the following items. If any parts are missing, please see your GARMIN dealer immediately.

Standard Package:

- GPSMAP Unit
- Remote GPS Antenna with 30' Antenna Cable
- Mounting Bracket and 2 Mounting Knobs
- Power/Data Cable (with fuse)
- Owner's Manual
- Antenna Combiner & cable (for GPSMAP purchased with built-in DGPS)
- Antenna Coupler and Whip Antenna (for GPSMAP purchased with built-in DGPS)

PART ONE: INTRODUCTION

Foreword.....	i
Cautions.....	ii
Limited Warranty & Registration.....	iii
Packing List.....	iv
Table of Contents.....	v-vi
Capabilities.....	vii
Keypad Usage.....	viii
The GPSMAP Tour.....	1-13

PART TWO: REFERENCE

Section 1: Satellite Status Page	15-16
Satellite and receiver status, entering initial positions	
Section 2: Map Page & Map Configuration	17-24
Using the target cursor, selecting zoom scales, calculating range and bearing, map configuration	
Section 3: Highway Page	25-26
Navigation data and steering guidance, highway scale	
Section 4: Active Route Page	27
Scrolling and reviewing the active route	



INTRODUCTION

Table of Contents



INTRODUCTION

Table of Contents

Section 5: Waypoints	28-33
Creating, editing and using waypoints; using the WAYPTS softkey	
Section 6: MARK Key	34
Marking present position and target cursor position	
Section 7: GOTO/MOB Keys	35-36
Going to a destination and using man overboard function	
Section 8: Routes	37-45
Creating, activating and modifying routes; using the ROUTES softkey	
Section 9: Auxiliary Menu / Menu Options	46-61
System, navigation and auxiliary functions and setups; using the AUX softkey	
Section 10: Using G-chart™ cartridges	62-64
Inserting, removing and using electronic chart cartridges; viewing port services information	
Appendix A: Installation	65-68
Appendix B: Wiring Installation / NMEA Formats	69-70
Appendix C: Physical Specifications	71
Appendix D: Messages	72-74
Appendix E: Time Offsets	75
Appendix F: Map Datums	76-78
Appendix G: Glossary	79-80
Appendix H: LORAN TDs	81-82
Index	83-85

Designed for detailed electronic charting and simple operation, the GARMIN GPSMAP system is a powerful navigation device that can help guide you in waterways around the world:

Precision Performance

- 16-color active-matrix TFT screen (GPSMAP 225)
- 3-Gray FTN LCD screen (GPSMAP 215)
- PhaseTrac12™ receiver tracks up to 12 satellites simultaneously for fast, accurate positioning
- Differential-Ready— available with optional built-in beacon receiver for under 10 meter accuracy
- Fully gasketed, high-impact plastic alloy case

Advanced Navigating and Plotting

- Over 1900 alphanumeric waypoints with selectable icons and comments
- Built-in worldwide database usable from 4096 to 64 n.m. scales
- 20 reversible routes with up to 50 waypoints each
- Graphic softkeys for easy operation right from the map display
- G-chart™ electronic charting for seamless, worldwide coverage
- On-screen point-to-point distance and bearing calculations
- 2,000 track log points with time, distance or resolution settings
- Built-in simulator mode for full route and trip planning

INTRODUCTION

Keypad Usage

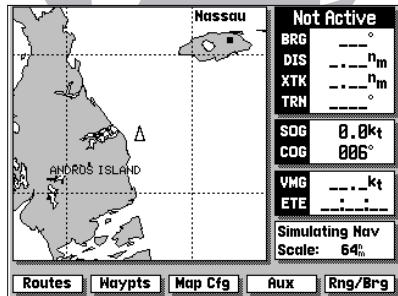

The GPSMAP system uses a set of on-screen 'softkeys'  to perform route, waypoint and setup functions. These softkeys allow you to perform many navigation functions and custom setups right from the map display.



The ZOOM key changes the map display scale to one of 16 available settings, or the highway display scale to one of five settings.



The CTR key eliminates the cursor and centers your vessel on the screen.



The ARROW KEYPAD controls the movement of the cursor and is used to select screen options and positions.



The ENTER key is used to confirm data entry and execute various on-screen function prompts.



The MAPS key returns the display to the map page and/or displays the outlines of chart coverage in use.



The PAGE key scrolls through the main screen pages in sequence.



The DATA key turns the data window on or off in map mode and toggles the displayed data on other pages.



The MENU key turns the softkey menu on or off in map mode.



The MARK key captures present position for storage as a waypoint.



The MOB key marks your present GPS position and instantly provides a return course with steering guidance.



The GOTO key lets you select a waypoint or target cursor position as a destination and sets a course from your present position.





The POWER key turns the GPSMAP on and off and adjusts the screen backlight level.

The GARMIN GPSMAP is a powerful electronic charting/navigating system that provides detailed chart coverage and convenient control of many advanced features right from the graphic charting page. This tour is designed to take you through the basic pages and functions of the GPSMAP system. Once you're familiar with the main pages and functions of the unit, refer to the reference section for instructions on performing specific tasks and functions.



Before beginning the GPSMAP tour, make sure the main unit and antenna have been properly installed (see Appendices A & B). Note that our tour will use the GPSMAP's built-in worldwide database and the simulator mode, so you won't have to install a chart cartridge or acquire satellites for this exercise. The tour assumes you have not changed any of the default settings for the unit. If you have changed any settings (position formats, units of measure, etc.), the descriptions and pictures in the tour may not match your configuration.

Powering Up and Starting the GPSMAP Tour

The GPSMAP's power and screen backlighting are controlled by the  key at the bottom left of the unit. To turn the GPSMAP on:

1. Press and hold the right side of the  key until the power tone sounds.
2. Once the welcome page appears, press the **ENT** key to acknowledge the mariner's warning notice and begin operation.

To adjust the screen backlighting level:

1. To increase the brightness level, press and release the right side of the  key.
2. To decrease the brightness level, press and release the left side of the  key.

GPSMAP TOUR

Power On

 **GARMIN®**
GPSMAP 215

WARNING: The electronic chart is an aid to navigation designed to facilitate the use of authorized government charts, not to replace them. Only official government charts and notices to mariners contain all information needed for the safety of navigation, and as always, the user is responsible for their prudent use.
Press <ENT> to acknowledge

The GPSMAP system is designed as an aid to navigation, and is not intended to replace the use of government-approved charts and traditional navigation practices. Make sure you read and understand the mariner's acknowledgement before using the unit.

GPSMAP TOUR

Simulator Setup

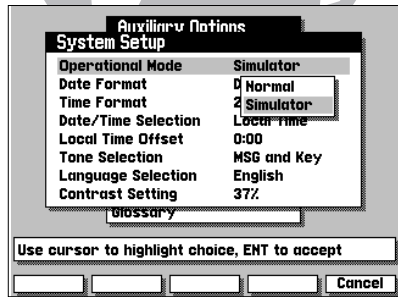







The GPSMAP system does not actively track satellites in the simulator mode. Never use the simulator mode for actual navigation. Any waypoints, routes and track logs you create while simulating navigation will be saved in memory, and are available for use when using the unit in normal operating mode.

Once you've acknowledged the mariner's warning, the Satellite Status Page will appear. The Satellite Status Page provides a visual reference of satellite acquisition and status, with a signal strength bar graph and satellite sky view in the center of the screen. The status field at the top left of the screen indicates the unit's operating mode, with current GPS accuracy displayed below.

Across the bottom of the screen, you'll find five on-screen menu buttons called 'softkeys'. Each softkey corresponds to the  key directly below it, and provides access to various route, waypoint and auxiliary functions. To see how softkeys work, let's put the GPSMAP in simulator mode:

1. Press the AUX softkey to display the Auxiliary Menu.



The Auxiliary Options Menu will appear, with the System Setup option highlighted. At the bottom of the screen, you'll notice a prompt field that provides you with instructions to help you through operating procedures.





1. With the System Setup option highlighted, press the  key.
2. The System Setup Menu will appear. Highlight the Operational Mode field, using the  keypad, and press  to see the available options.
3. Use the  keypad to highlight 'Simulator' and press  to accept.
4. Press  to acknowledge the simulator warning notice.
5. Press the EXIT softkey to return to the Auxiliary Options menu.
6. Press the EXIT softkey again to return to the Satellite Status Page.

Your GPSMAP is now in simulator mode.

GPSMAP TOUR

Entering a Position

Now that you are back at the Satellite Status Page, let's enter a starting position for our tour. Entering names and numbers in the GPSMAP system is done through data entry windows. Once a data entry window is open, the  keypad and  key are used to choose and accept a value for each character position:

1. Press the  key to highlight the position field (top right).
2. Press the  key to begin entry of the following position:
N 24° 43.111', W 077° 42.400'.
3. Use the  keypad to highlight the appropriate character choice for each field.
4. Press the  key to accept each choice and move to the next character position. When you accept a value for the last character position, you will automatically return to the Satellite Status Page.



If you need to correct a mistake or change values in a character field, use the appropriate softkeys at the bottom of the screen. Use BKSPC to move back one character position; CLEAR to erase all entered data; and RESTORE to restore the previous field value. The OK softkey accepts data entry and returns the display to the previous page, and the CANCEL softkey stops the current data entry mode.

The Satellite Status Page will now indicate the position you entered and give you a simulated display of signal strength and satellite position. To continue the tour, let's move on to the Map Page.

1. Press the  key to display the Map Page.

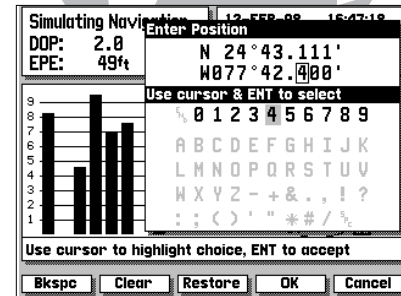

Use the  KEYPAD to choose letters, numbers, spaces and symbols in a data field. Only the appropriate characters will be available for a particular data entry window.

GPSMAP TOUR

Map Page

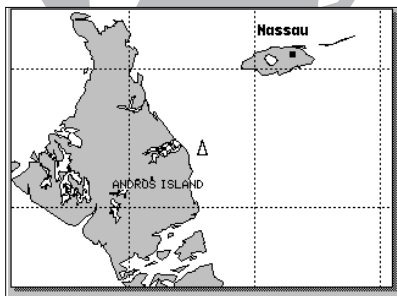

The Data Window (at the right side of the screen) and the Softkey Menu Display (at the bottom of the screen) may be turned off for a full page display of cartography:

- To turn the Data Window off, press **DATA**.
- To turn the Softkey Menu off, press **MENU**.

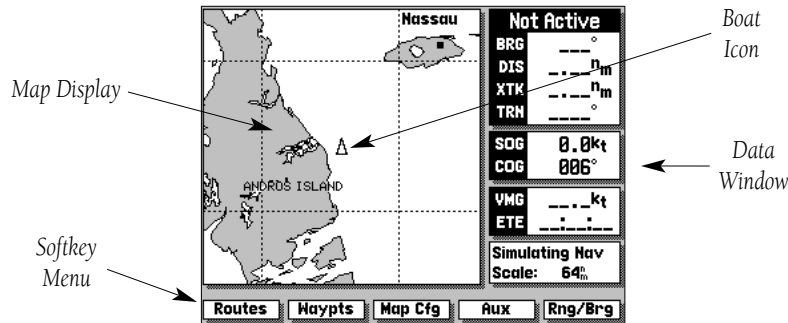

The GPSMAP system is built around a powerful graphical Map Page. The Map Page combines digital electronic charting with a complete display of important navigational data and easy access to advanced features. After completing the tour, you'll be able to perform most navigation, waypoint and route functions directly from the Map Page. Before we start creating waypoints and routes, let's take a brief look at its various features and displays.

The Map Page can be broken down into three main sections: map display, data window and softkey menu.

The **map display** shows your boat as a wedge icon on an electronically generated chart, complete with geographic names, markers, buoys and depth contours. It also displays your track, routes and nearby waypoints. An on-screen target cursor lets you pan to other map areas, determine the range and bearing to a position and perform various route and waypoint functions.

The **data window** provides a digital display of navigation data, in relation to your present position, the target cursor position or a particular waypoint.

The destination field, located at the top of the data window, shows your bearing (BRG) and distance (DIS) to a destination waypoint or to the cursor. It also displays your crosstrack error (XTK) and turn (TRN) heading to an active destination. The XTK value is the distance you are off a desired course (left or right), while TRN represents the direction (left or right) in degrees between your course over ground (COG) and the bearing to your destination.

The speed and course field, located below the destination field, displays your present speed and course over ground (SOG and COG).

Below the speed and course field are the arrival and status fields. The arrival field displays your velocity made good (VMG) and estimated time enroute (ETE). Your velocity made good is the speed you are closing in on a destination along your desired track, while the ETE represents the total time left to reach your destination based on your current VMG.

The status field indicates the operating mode and map scale currently in use. The map scale represents the approximate distance from the top of the map display to the bottom.

The **softkey menu** provides you with direct access to the GPSMAP's route, waypoint, auxiliary and range/bearing calculation functions.

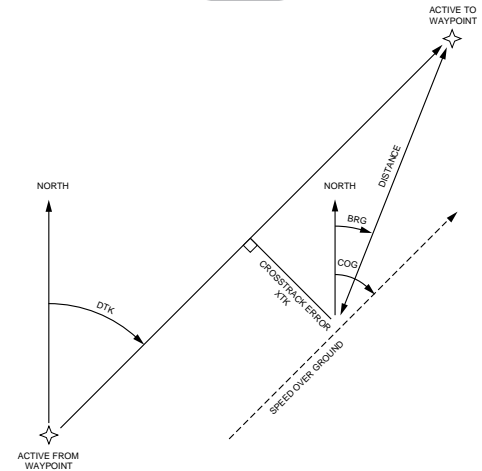
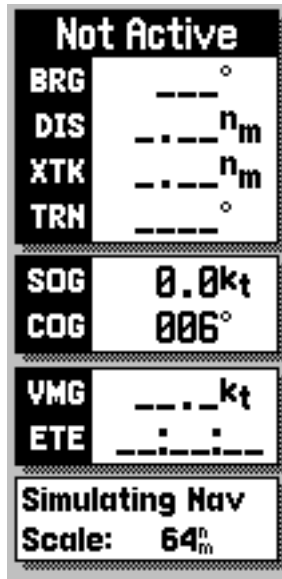

*Basic Navigation Terms:
For a glossary of navigation terms, select the 'Glossary' option from the Auxiliary Options Menu or see pages 79-80.*



GPSMAP TOUR

Using the Target Cursor

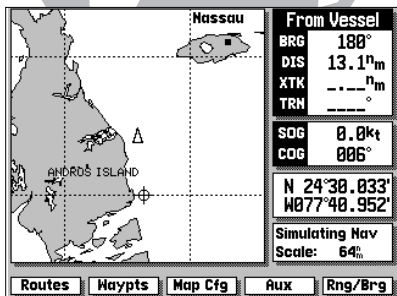

As you move the cursor, the distance and bearing from your present position to the cursor will be displayed in the destination field (at the top right of the screen).

The cursor's position coordinates will be displayed in the position field (below the speed and course field).

While in cursor mode, the boat icon will continue to move, and may go off screen to accommodate the scrolling cursor.

Using the Map Page is a simple process that centers around the use of the cursor. Controlled by the arrow keypad, the cursor is an important tool that can be used as a distance and bearing marker, to create new waypoints and routes, and to review position data of on-screen waypoints, buoys and markers. Try moving the cursor using the following exercise:

1. Use the **ZOOM** key to set the map scale to 64 n.m.
2. Your boat should be in the center of the map display, near Andros Island and Nassau (the position you entered earlier).
3. Press the bottom arrow of the **UP** keypad to move the cursor down to the first lat/lon grid South of your boat's position.
4. Using the **UP** keypad to move the target crosshair in each direction, try following the outline of the lat/lon grid closest to your boat. Notice how the outline of the data window displays the distance and bearing from your position to the target cursor, with the cursor's coordinate position indicated in the position field.
5. Press the **CTR** key to eliminate the cursor and re-center your position on the map display.

As you become more familiar with using the cursor, you'll see that the map display actively scrolls forward with your panning, letting you explore areas around the world (even outside of your current G-chart™ coverage) and create waypoints and routes. Wherever you move the cursor, you'll always be one **CTR** keystroke away from returning to your present position.

GPSMAP TOUR

Marking a Position

To continue the tour, let's mark our simulated present position for reference:

1. Press the **MARK** key to capture your present position as a waypoint.

The Mark GPS Position window will appear, with a default three-digit waypoint name and symbol. By pressing the **ENT** key, you can confirm the waypoint with the default name and symbol, but let's change the name and symbol to something a little more meaningful:

1. Use the **0** keypad to move the field highlight to the 'Wpt' field and press **ENT**.
2. Enter the name 'DAY1' with the **0** keypad, pressing **ENT** after each character.
3. After you've entered the last letter, press the OK softkey to confirm the name.
4. The field highlight will move to the waypoint symbol field. Press **ENT** to begin selection of a new waypoint symbol.
5. Use the **0** keypad to highlight the fish symbol (on the second line of the window) and press the **ENT** key.
6. The field highlight will move to the comment field, where you may enter a 20-character comment (the default comment is the date and time of creation).
7. Press **ENT** to begin entry of a comment.
8. Use the **0** keypad to enter 'TOUR' in the comment field, pressing the **ENT** key after each character.
9. Press the OK softkey to accept your comment.
10. Use the **0** keypad to highlight the OK field.
11. Press the **ENT** key to save your new waypoint.

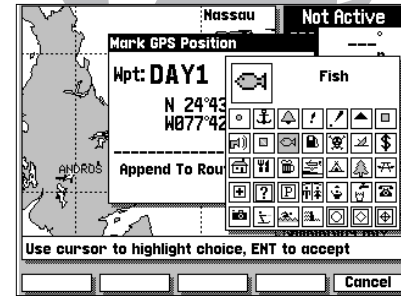

The GPSMAP system stores over 1900 alphanumeric waypoints, with selectable graphic icons and a user-defined comment field. If you mark a navaid position that appears on a G-chart electronic cartridge, the default comment will automatically select the navaid text associated with the marker.

GPSMAP TOUR

Creating a Route

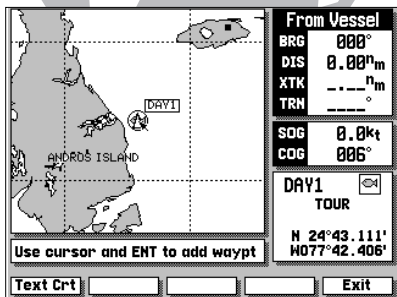



Whenever the cursor comes in close proximity to an on-screen waypoint or navaid, it will 'snap' to and highlight its on-screen icon.

Once an on-screen marker has been highlighted, destination and position information will be displayed in the data window.

This feature makes it easy to review waypoint positions right from the map display.

Now that you've marked a waypoint for your starting position, let's make a route to navigate using the ROUTES softkey. (For the purposes of this tour, make sure that the current map scale is still at 64 n.m.)

1. Press the ROUTES softkey to begin creating a route.
2. Use the  keypad to highlight the Route 1 field and press .





The GPSMAP system can store 20 reversible routes of up to 50 waypoints each. Routes 1-19 are used as storage routes, with Route 0 always serving as the active route. Although you may create a route in the Route 0 position, be aware that it will automatically become the active route upon completion. If you want to save a route created in the Route 0 position, be sure to copy it to another storage route, as it will be overwritten by the next route activation (see Section 8 for more details on routes).

As the GPSMAP returns to the Map Page, you'll notice several changes. The map display will now show the cursor as an arrow at your present position, with the prompt field indicating instructions for adding waypoints to your route. To select the DAY1 waypoint as your first route waypoint:

1. Press the  key to add the waypoint to the route.

Now add the next waypoint to the route:

1. Use the  keypad to move the arrow cursor as close as possible to the following coordinates: N 24° 27.371', W 077° 42.407'.
2. Press  to save the waypoint position.
3. Press  to confirm the default waypoint name, symbol and comment.

GPSMAP TOUR

Modifying a Route Graphically Activating a Route

Now add the final waypoint to the route:

1. Use the **⬇️** keypad to move the arrow cursor as close as possible to the following coordinates: N24°21.777', W077°51.424.
2. Press the **ENT** key to save the waypoint position.
3. Press **ENT** to confirm the default waypoint name, symbol and comment.

We now have a three waypoint route from our present position to waypoint 002. To activate the route and begin navigation:

1. Press the EXIT softkey to quit the route creation mode.
2. Press the ACTIVTE softkey.

The GPSMAP will return to the Map Page, with your active route (Route 0) shown on the map display and the 'active to' waypoint (001) displayed in the destination field. The speed and course field tells us we're getting nowhere fast, so let's go to the Highway Page and enter a speed for our simulated trip:

1. Press the **PAGE** key to display the Highway Page.

The Highway Page provides you with a large, digital display of navigation data and graphic steering guidance to an active destination via a three-dimensional perspective of your course. As you head toward your destination, the middle of the screen provides visual guidance on a moving "graphic" highway.

Your present position is at the bottom of the highway display. The line down the middle of the highway represents your desired course. As you navigate toward a waypoint, the highway will actually move—indicating the direction you're off course. To stay on course, simply steer toward the center of the highway.

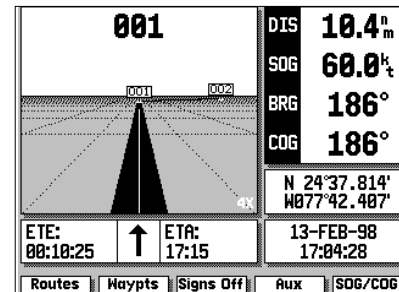
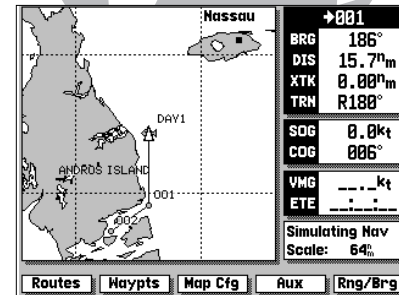

GPSMAP TOUR

Navigating a Route

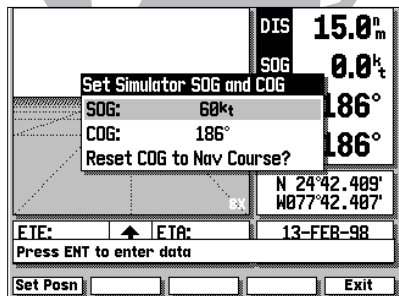

The Simulator SOG/COG window lets you specify the speed and course for the simulator mode. By leaving the COG field value at the default setting, the GPSMAP system will automatically set a course directly to your destination.

If you choose to enter your own course over ground, highlight the COG field and enter the desired course. To reset the simulator to steer a direct course for you, highlight the 'Reset COG to Nav Course' prompt and press the **ENT** key.

The active destination waypoint is displayed at the top of the screen, with the ETE (estimated time enroute) and ETA (estimated time of arrival) based on your present speed and course at the bottom.

The distance and bearing to the first route waypoint, along with your current speed and course over ground (SOG and COG), are indicated along the right-hand side of the screen. The SOG and COG fields can be changed to display velocity made good (VMG) and turn (TRN). To toggle the speed and course displays, press the **DATA** key.

Now enter a speed of 60 knots for our simulated trip:

1. Press the SOG/COG softkey to display the Simulator SOG/COG window.
2. Press the **ENT** key to begin data entry.
3. Use the **0** keypad to enter a speed of 60 knots, pressing the **ENT** key after each character entry.
4. Once you've entered your speed, press the EXIT softkey.

By leaving the COG field value at the default setting, the GPSMAP system will automatically set a direct course to each route waypoint. If you choose to enter your own course, highlight the COG field and enter the desired course. To reset the simulator to automatically steer a direct course for you, highlight the 'Reset COG to Nav Course' prompt and press the **ENT** key.

At the bottom right corner of the highway display is the highway scale. The highway scale ranges from '1X' to '16X', and allows you to change the perspective view of the highway to show a larger or smaller area.

1. Press the down arrow on **▼ZOOM▲** to decrease the scale and show a smaller area.
2. Press the up arrow on **▼ZOOM▲** to increase the scale and show a larger area.

GPSMAP TOUR

Active Route Page

You are now underway toward the first waypoint in your route. Whenever there is an active route in use for navigation, the GPSMAP will display route waypoint and leg information on the Active Route Page. To view the Active Route Page from the Highway Page:

1. Press the **PAGE** key.

The Active Route Page shows each waypoint of the active route in sequence, along with the desired track, distance and ETE or ETA to each waypoint from your present position. As you navigate a route, the waypoint list will automatically update to list the next 'active to' waypoint first, followed by the remaining route waypoints in sequence. From the Active Route Page, you can:

1. Scroll through the entire list of route waypoints using the **▲** key.
2. Review a highlighted waypoint by pressing the **ENT** key.
3. Change the ETE field to display ETA by pressing the **DATA** key.

Let's go back to the Map Page to look at our progress:

1. Press the **MAPS** key.

As you travel along your route, your boat will move across the map display, leaving a track plot of your course. You may have some difficulty differentiating track plots and route legs at the 64 n.m. scale, so try zooming down past the built-in database with **▼ZOOM▲** to get a good view of the track plot.



Whenever you zoom past the usable range of the current electronic chart, the range field will display 'Ovr Zm' or 'No Map'. These warnings indicate that although you may still have cartography, you should exercise extreme caution using the data. For a more detailed explanation of Overzoom and No Map modes, see page 20.

Active Route				
Waypoint	Type	Dsrd Trk	Distance	ETE
▶ 001	○	186°	10.0 ⁿ m	00:10:01
3 002	○	242°	20.0 ⁿ m	00:19:58
4	○	---	--- ⁿ m	---
5	○	---	--- ⁿ m	---
6	○	---	--- ⁿ m	---
7	○	---	--- ⁿ m	---
8	○	---	--- ⁿ m	---
9	○	---	--- ⁿ m	---

Use cursor to review route

Routes Waypts Map Cfg Aux Delete

	→001
	BRG 186°
	DIS 6.44 ⁿ m
	XTK 0.00 ⁿ m
TRN 0°	
SOG 60.0 ^k t	
COG 186°	
VWG 60.0 ^k t	
ETE 00:06:26	
Simulating Nav	
Ovr Zm: 16%	

Routes Waypts Map Cfg Aux Rng/Brng

Map Display in Overzoom Mode

GPSMAP TOUR

Marking a GOTO Destination

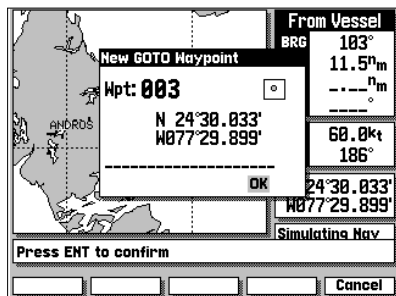
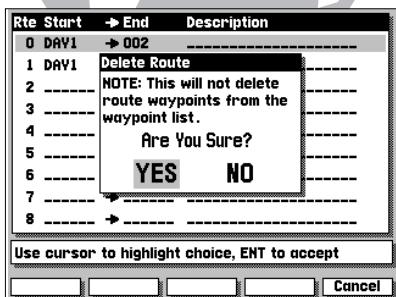

As you approach a destination waypoint, an audible alert and on-screen message will indicate when you are one minute from your destination. To acknowledge the message:

1. Press the **ENT** key.

Whenever you're finished navigating a route with the GPSMAP system, you'll need to clear the Active Route to stop navigation guidance to the last route waypoint. To stop navigation of the Active Route:

1. Press the ROUTES softkey.
2. Press the DELETE softkey, followed by **ENT**. (Press the EXIT softkey to return to the previous page.)

Although creating and navigating routes in the GPSMAP system is a simple process, there may be times when you want to head right to a specific destination without creating a route. Imagine that as you were navigating the current route, you see a spot of interest off the starboard bow. By marking a new position with the cursor and using the GOTO function, we can set a new course right from the map display:

1. Use the **ENT** keypad to move the cursor as close to the following position as possible: N 24° 30.000, W 077° 30.000.
2. Press the **GOTO** key.

Notice that the cursor has become an arrow pointer, and the prompt field displays instructions for going to the cursor position.

1. Press the **ENT** key.
2. The New GOTO Waypoint window will appear, asking you to confirm the waypoint name, position and details. Press the **ENT** key to confirm the information.

The GPSMAP will now provide you with steering guidance to your new waypoint. To stop navigation to a GOTO destination, clear the active GOTO:

1. Press the **GOTO** key.
2. Press the CLR GOTO softkey. (Note that in simulator mode, navigation will continue along the previously defined course over ground.)

Congratulations! You've now gone through the basic operation of the GARMIN GPSMAP system. Your new unit is a powerful navigation device with many advanced features not covered in the tour.

Now that you have a working knowledge of the unit, use the reference section of this manual to help you with advanced navigation and setup functions. The reference section is organized by topic, so you can quickly find instructions for performing specific functions, including the installation and use of G-chart™ electronic navigation charts.

To turn your GPSMAP off:

1. Press and hold the left side of the **OFF/ON** key for three seconds.

Thank you for choosing the GARMIN GPSMAP Navigation System. We hope it will be a useful navigation tool for you wherever you may travel. If you have any questions or comments about its use, please call our Product Support staff at 913-397-8200. You may also FAX our Product Support staff at 913-397-8282.

GPSMAP TOUR

Power Off

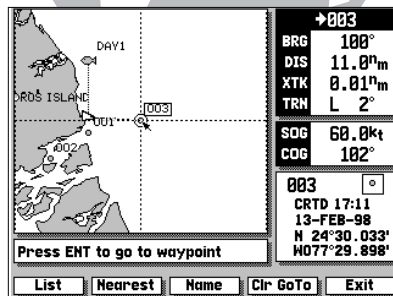

Press CLR GOTO to stop navigation.

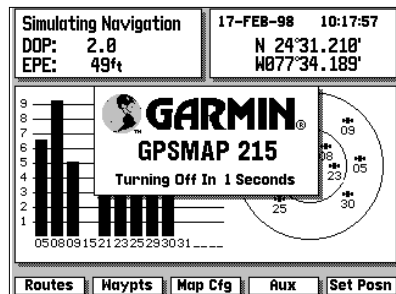

REFERENCE SECTION

- 1 – SATELLITE STATUS PAGE
- 2 – MAP PAGE
- 3 – HIGHWAY PAGE
- 4 – ACTIVE ROUTE PAGE
- 5 – WAYPOINTS
- 6 – MARK KEY
- 7 – GOTO/MOB
- 8 – ROUTES
- 9 – AUXILIARY MENU
- 10 – G-CHART CARTRIDGES

SATELLITE STATUS PAGE SECTION 1

Overview

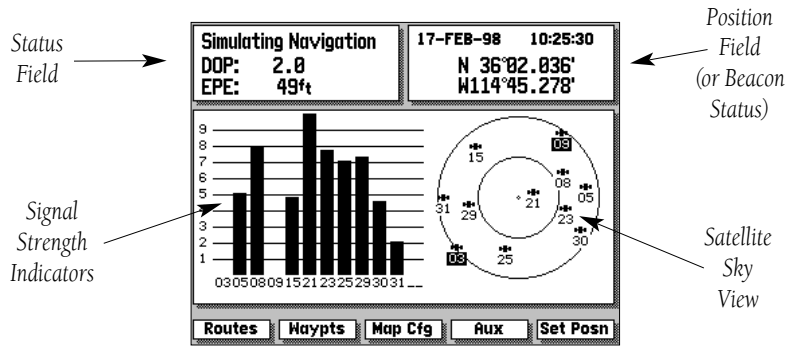

The GPSMAP 215/225 Satellite Status Page provides a visual reference of various receiver functions, including current satellite coverage, receiver operating mode and present position or DGPS status. The status information will give you an idea of what the receiver is doing at any given moment.

The sky view and signal strength bars give you an indication of what satellites are visible to the receiver and whether or not they are being tracked. The signal strength is shown on a bar graph for each satellite, with the satellite number below. When a satellite is visible but not being tracked, the strength bar will remain blank and the sky view indicator will remain highlighted.

The sky view shows a bird's eye view of the position of each satellite relative to the receiver's last known position. The outer circle represents the horizon (North up); the inner circle 45° above the horizon; and the center point a position directly overhead. Use the sky view to determine if there are obstructions shading your reception of GPS signals.

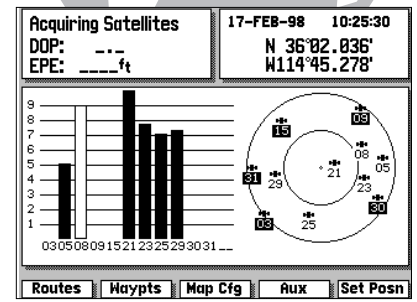

In this example, satellites 5, 21, 23, 25 and 29 are currently being tracked, with the corresponding signal strength bars indicating the relative strength of the signals. Satellites 3, 9, 15, 30 and 31 (shown with numbers highlighted) are visible, but are not currently being tracked. Satellite 8 is being received (as indicated by a hollow bar), but the data is not yet available for use in determining your position.

NOTE: For first time operation, GPSMAP 215 and 225 units may require 5 minutes to collect initial satellite almanac data and establish a present position. You may speed up the initial acquisition process by entering an initial position (see page 16).

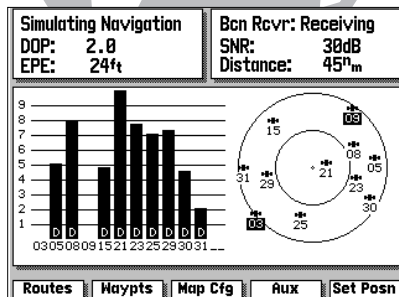

Whenever your GPSMAP is operating with a DGPS beacon receiver, the position window will be replaced by a beacon receiver status window. This window will display the beacon receiver status, the signal-to-noise ratio (SNR), and the distance from your beacon receiver to the DGPS transmitter. (If available)

GPSMAP 215/225 units purchased without the internal beacon receiver can be upgraded to DGPS accuracies using the GARMIN GBR 21 or GBR 23 beacon receiver.

The Satellite Status Page also shows receiver status and the current horizontal accuracy at the top left of the screen. The operating mode field will indicate whether the receiver is acquiring satellites, or is in simulator, 2-D, 2-D differential, 3-D or 3-D differential mode; with the current dilution of precision (DOP) and estimated position error (EPE) displayed below.

DOP is a measurement of satellite geometry quality, measured on a scale of one to ten (lower numbers being the best, higher numbers the poorest). The EPE uses the DOP and other factors such as signal quality to calculate a horizontal position error in feet or meters.

At the top right of the screen, your present position and the current date and time are displayed in the position window. The position shown will be the receiver's last calculated position. If you have moved more than 300 miles from your last position, you may want to enter a more accurate position to speed up satellite acquisition (or select AutoLocate™ mode, as described on page 48). You may enter your own position coordinates—by data entry or graphically—whenever the GPSMAP is acquiring satellites or is in simulator mode.

To enter new position coordinates by data entry:

1. Highlight the position field and press the **ENT** key to begin data entry.
2. Use the **0-9** keypad to enter the new position, pressing the **ENT** key after each character is selected.

To enter new position coordinates graphically:

1. Press the SET POSN softkey.
2. Use the **0-9** keypad to move the cursor to the desired position on the map display and press the **ENT** key.
3. Press the EXIT softkey to return to the Satellite Status Page.

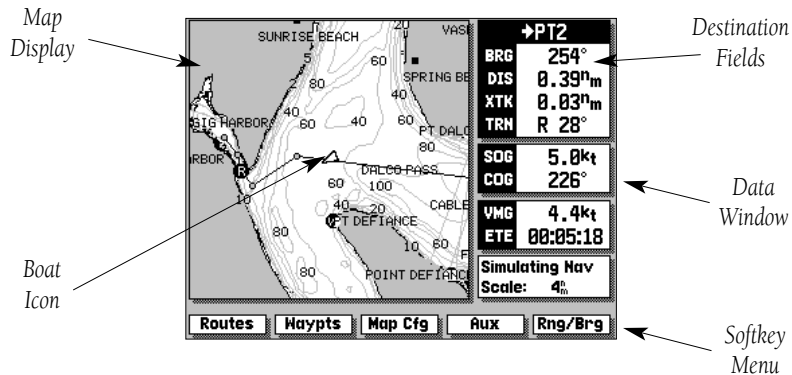

The GPSMAP Map Page provides a comprehensive display of electronic cartography, plotting and navigational data. It is the primary page used for navigating with the GPSMAP system. The Map Page can be broken down into three main sections: map display, data window and softkey menu.

The map display shows your boat on an electronically generated chart, complete with geographic names, nav aids, depth contours and a host of other chart features. It also plots your track and displays any routes and waypoints you create. An on-screen cursor lets you pan and scroll to other map areas, determine the distance and bearing to a position, and perform various route and waypoint functions. The GPSMAP system has a built-in worldwide database to 64 n.m. (see Appendix F for built-in coverage map), with more detailed coverage available through the use of G-chart™ data cartridges (see Section 10 for installing and using G-chart™ cartridges).

MAP PAGE

SECTION 2

Overview

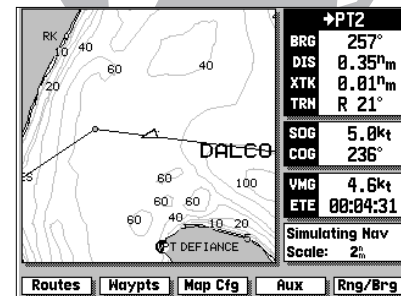

Your boat's position is represented by a wedge icon, with your track plot shown as a dotted line (GPSMAP215) or a solid yellow line (GPSMAP225).

To select what chart features are displayed on a particular chart scale, refer to the Map Configuration section on pages 23-24.

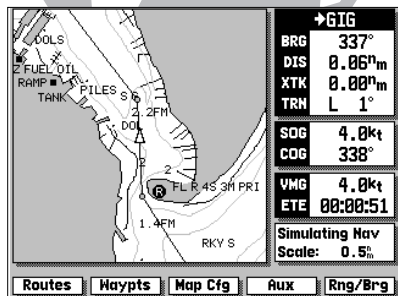

Boat Mode

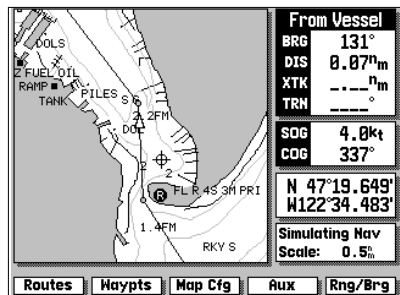

Cursor Mode

The map display uses the cursor keypad and a set of hard keys to control most map display functions. The **ZOOM**, **CTR**, **ENT** and **MAPS** keys, combined with the **⬇** keypad lets you select zoom ranges, move the cursor and display chart outlines. Two basic map operating modes determine what cartography is shown on the map display: boat mode and cursor mode. Boat mode pans the cartography to keep the present position marker within the display area, while cursor mode pans the cartography to keep the cursor within the display area.

The GPSMAP system will always power up in the boat mode, with your vessel centered on the map display. In boat navigation mode:

- Your movement is shown by the map scrolling past the centered boat.
- Whenever sufficient map coverage is not available to keep the boat centered, the boat icon will move toward the edge of the display.
- If the boat icon attempts to go off the display, the zoom level may need to be adjusted to keep cartography on screen.

Whenever the **⬇** keypad is pressed, the GPSMAP will enter cursor mode. In cursor mode:

- The cursor can be moved over the map display using the **⬇** keypad.
- Whenever the cursor reaches the edge of the display, the map will scroll forward under the cursor. Keep in mind that the boat icon will move with the map scrolling, and may go off the display screen (you may not be able to see your present position).
- When the cursor is stationary, a fixed coordinate position will appear in the position field. Note that the distance and bearing, displayed in the destination field, will change as your boat's position changes.
- Whenever you zoom in cursor mode, the cursor will be centered on screen.

The cursor allows you to pan away from your present position and scroll to other map areas around the world (even outside of your current G-chart™ coverage). As you pan past the edge of the current map display, the screen will actively scroll forward to provide continuous map coverage wherever you move the cursor.

To move the cursor:

1. Press the appropriate arrow icon on the  keypad to move the cursor in the desired direction.

As you move the cursor, the distance and bearing from your present position to the cursor, will be displayed in the data window, with the cursor's position coordinates shown in the position field. Keep in mind that when the cursor is stationary, the distance and bearing from your present position will change as your boat moves.

The cursor may also be used to 'snap' to on-screen waypoints and nav aids, allowing you to review the selected position directly from the map display

To select an on-screen waypoint or navaid with the cursor:

1. Use the  keypad to move the cursor to the desired waypoint or navaid. (If there are several waypoints grouped closely together, zoom in closer for a better view of the area.)
2. When a waypoint or navaid is selected, it will become highlighted on-screen, with the name, position, comment and icon displayed in the data window.

To eliminate the cursor, re-center your position on-screen and return to the boat navigation mode:

1. Press the  key.

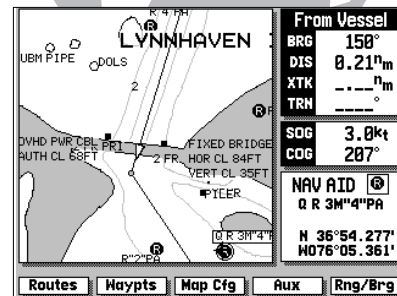

Snapping to an on-screen waypoint

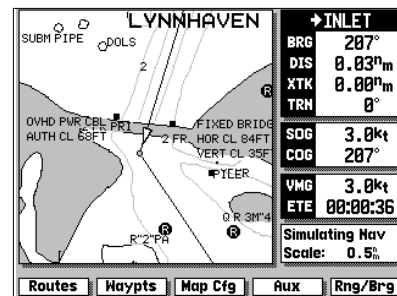

Remove the cursor by pressing the  key

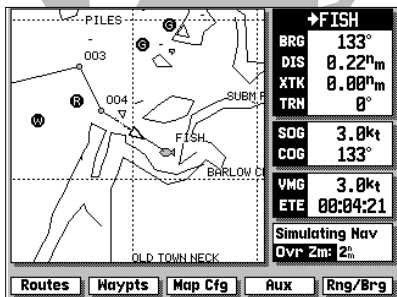

Overzoom Mode

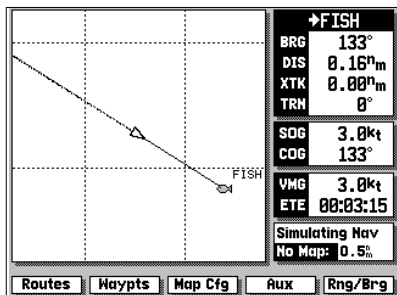

Track Plot Mode

The map display has 16 available range scales from 1/8th to 4096 n.m. (1/4 to 7500km). The map scale is controlled by the **ZOOM** key, with the current scale displayed at the bottom of the data window.

To select a map scale:

1. Press the arrow icon on the right or left side of the **ZOOM** key to zoom in or out.

The GPSMAP will display cartography as long as there is chart information available for the range you've selected. Zooming operation will conform to the following default settings:

- When the selected zoom range is covered by either the internal database or a G-chart™ data cartridge, cartography will be displayed.
- When the selected zoom range is covered by both the internal database and a G-chart™ cartridge, cartography will be displayed using the data with the best resolution.
- When the selected zoom range exceeds the resolution of the chart in use by up to two settings, OVERZOOM cartography will be displayed. The display will not show any filled landmass areas, and an 'Ovr Zm' warning will appear in the scale field and the lat/lon grid will be turned on regardless of the map configuration setting. Although OVERZOOM cartography provides some level of map detail, additional caution should be used while navigating.
- When the selected zoom range exceeds the resolution of the chart in use by more than two settings, a 'No Map' warning will appear and all cartography will be replaced by a TRACK PLOT display. The lat/lon grid will be displayed regardless of the map configuration setting. Additional caution should be used while navigating in track plot mode.

The second section of the Map Page is the data window, located at the right side of the screen display. The data window provides a digital display of navigation data in relation to your present position, the cursor position or a particular waypoint.

The top area of the data window includes the destination fields, which display the bearing and distance to the destination waypoint indicated, with crosstrack error (XTK) and turn value (TRN) shown at the bottom. If there is not an active destination waypoint, 'Not Active' will be indicated above the destination fields. The XTK value is the distance you are off a desired course, while TRN represents the direction in degrees between your course over ground (COG) and the bearing to your destination. Whenever the cursor is in use, the destination field will display the distance and bearing from your present position to the cursor.

The speed and course fields, located below the destination fields, display your present speed and course over ground (SOG and COG). Directly below these fields are the arrival and status fields. The arrival fields display your velocity made good (VMG) and estimated time enroute (ETE). VMG is the speed you are closing in on a destination along the desired track, with the ETE representing the total time left to your destination based on your current VMG. Whenever the cursor is in use, the arrival fields will be replaced by a position field, which displays the coordinates of the cursor.

The status field, located directly below the arrival field, indicates the operating mode and map scale currently in use. When the cursor is used to 'snap' to an on-screen waypoint or navaid, the arrival and status fields will be replaced with a waypoint review field, showing the name, position, icon and comment for the selected on-screen position.

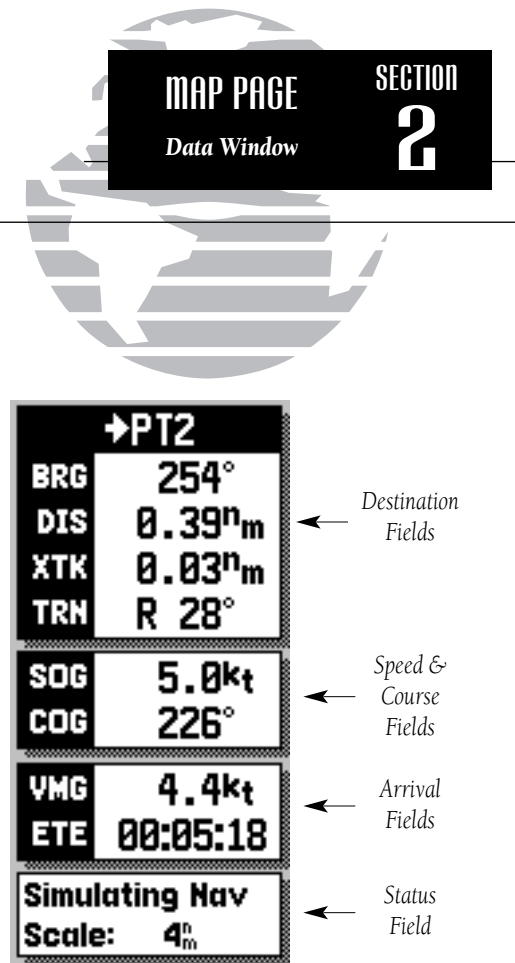

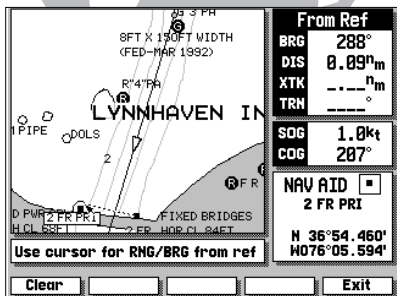

Calculating Range/Bearing

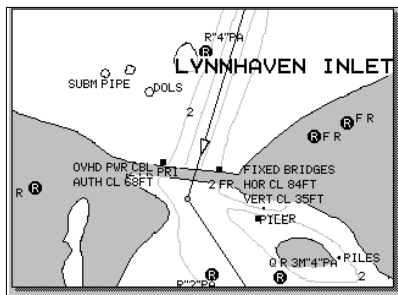

Expanded Map Display

The last section of the Map Page is the softkey menu, which is displayed across the bottom of the screen. The first two softkeys provide quick access to route and waypoint functions from any GPSMAP page. The AUX softkey provides instant access to the Auxiliary Menu. For instructions on using these softkeys, refer to the section dedicated to each key. The RNG/BRG softkey appears only on the Map Page, and lets you use the cursor to calculate the range and bearing between any two on-screen positions.

To calculate the distance and bearing between two points:

1. Press the RNG/BRG softkey.
2. Use the keypad to move the arrow cursor to the desired reference position and press the **ENT** key. To clear a reference point, press the **CLEAR** softkey.
3. Use the keypad to move the arrow cursor to the desired finish position. The bearing and distance from the reference point will be displayed in the destination window.
4. Press the **EXIT** softkey to quit the RNG/BRG mode.

Although the Map Page's data window/softkeys provide you with important data and system functions, you may prefer to have a full-screen map display. To display cartography on the entire page, simply 'turn off' the other displays.

To turn the data window display on or off:

1. Press the **DATA** key.

To turn the softkey menu display on or off:

1. Press the **MENU** key.

The GARMIN GPSMAP system features a graphic map display with 16 zoom scales from 1/8th to 4096 n.m. (1/4 to 7500km). By using G-chart™ inland and offshore chart cartridges, the map display can show a wide variety of chart details such as depth contours, shorelines, marinas and navigation aids.

The MAP CFG softkey allows you to determine what chart features are displayed on a particular range scale. By selecting individual features on the map configuration windows, you can choose what specific information to display.

To access the map display configuration windows:

1. Press the MAP CFG softkey.

The configuration windows feature an on/off grid with a list of chart features down the left side of the grid. The zoom scales are displayed across the top of the grid, with the chart scale currently in use indicated by a box outline around the selection grid. The far left column denotes range scales 64 n.m. (120 km) and greater. A check mark in a grid box indicates that the chart feature listed will be displayed at the scale marked at the top of the grid. A configuration grid is available for Marine and Land data.

To select a configuration window for Marine or Land data:

1. Press the MARINE or LAND softkey (as appropriate).

Individual grid boxes are turned on and off with the **ENT** key, while entire rows may be controlled by using the configuration softkeys.

To use the map configuration grid:

1. Use the **ENT** key to toggle an individual grid box on or off.
2. Press the **DEFAULTS** softkey to return the entire grid to the factory settings.
3. Use the **SET ROW** softkey to turn an entire horizontal row on.
4. Use the **CLR ROW** softkey to turn an entire horizontal row off.

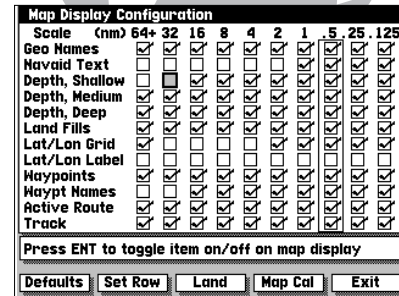

Marine Data Configuration

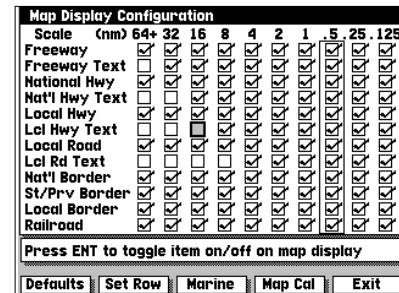

Land Data Configuration

SECTION 2

MAP CONFIGURATION

Map Calibrations

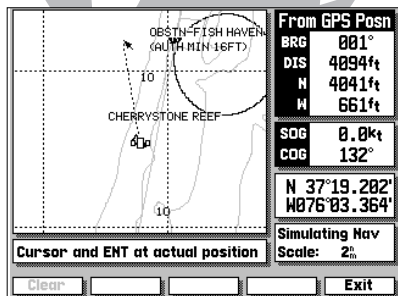

WARNING!

The map calibration function is valid only in a limited range. The further you are away from the point of correction, the larger the position error will be. Keep in mind that Selective Availability can cause position errors up to 330 feet (100 m).

The map calibration function should NEVER be used to attempt SA corrections. Any incorrect use of the calibration function can seriously affect the accuracy of your unit.

Note that geographic names and navaid text can't be displayed simultaneously at range scales greater than 2 n.m. (4 km) and that navaid text is always available in the review window by highlighting the navaid with the cursor. Waypoint names and lat/lon labels cannot be displayed unless the waypoints or lat/lon grid options have been selected. The lat/lon grid will always appear in Overzoom and No Map modes, regardless of the configuration selection.

The map display configuration windows also feature a map calibration softkey to provide access to a user-defined map correction function. This function allows you to calibrate the map display to match your exact physical position (see left for Selective Availability warning) or correct data from older charts.

If your GPSMAP is not providing an accurate display of your position (within the estimated position error noted on the *Satellite Status Page*), check to see that your GPSMAP map datum matches the datum on the chart(s) you are using (see Section 9 for selecting a map datum). To calibrate the map display, you must know exactly where you are, and understand that the correction is generally valid only in a limited range from the point of correction. You should also only perform a map calibration when your boat is not moving. The maximum correction is 16,400 feet (5000m). *Note that all map calibration offsets will stay in effect until they are cancelled!*

To perform a map calibration from the map configuration window:

1. Press the MAP CAL softkey.
2. Use the  key to move the arrow cursor from the satellite position (indicated by the satellite icon) to your exact position. The bearing, distance, and horizontal and vertical offset will be indicated at the top of the data window, with the position coordinates indicated in the position field.
3. Press **ENT** to confirm the offset, and EXIT to return to the configuration window.
4. To cancel a map calibration offset, press the MAP CAL softkey. When the map display appears, press the CLEAR softkey, followed by the EXIT softkey.

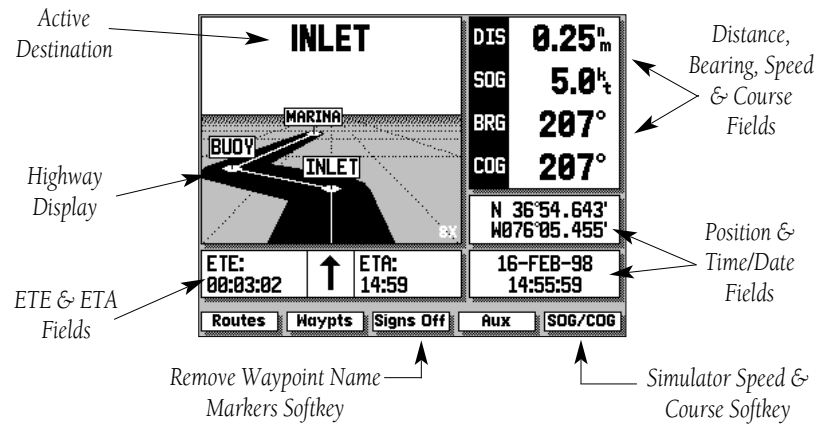

The GPSMAP Highway Page provides a large character display of navigation data and graphic steering guidance to an active waypoint via a highway display. The active destination waypoint is displayed at the top of the screen, with the ETE (estimated time enroute) and ETA (estimated time of arrival) based on your present speed and course at the bottom.

The distance and bearing to the destination waypoint, along with your present speed and course over ground (SOG and COG) are shown along the right hand side. The SOG and COG fields may also be changed to display your velocity made good and turn value (VMG and TRN).

To display VMG and TRN:

1. Press the **DATA** key. To return the display to SOG and COG, press **DATA** again.

The last two fields on the Highway Page are the position and date/time fields. The position field displays your present GPS position or a simulator mode position you have entered manually. The date/time field displays the

HIGHWAY PAGE SECTION 3

Overview

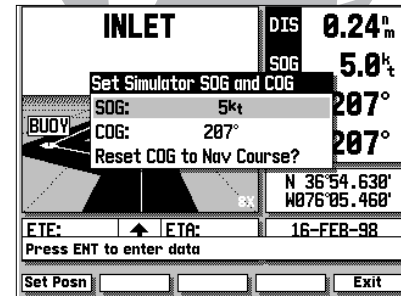

The **SIGNS OFF** softkey allows you to remove the waypoint name markers which appear on the graphic highway display.

Whenever your GPSMAP is in simulator mode, a **SOG/COG** softkey will appear in the softkey menu. Use the **SOG/COG** softkey to set the speed and course for your simulated trip (see pg. 9-10).

Once you are in the **SOG/COG** window, you can also set a simulator position graphically by pressing the **SET POSN** softkey and following the steps outlined on page 16.

SECTION 3 HIGHWAY PAGE

Highway Display & Scale

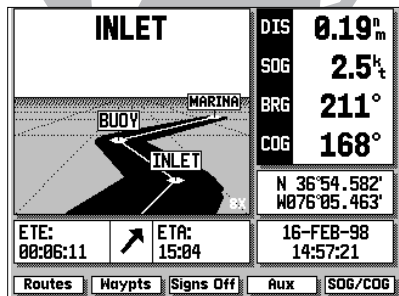

The bearing pointer, directly below the highway display, always points to the destination waypoint (or the next waypoint when using a route) relative to your course over ground (COG). If the bearing pointer points straight ahead, you are heading directly to your destination. If the bearing pointer points any direction other than up, turn toward the arrow until it points up—then continue in that direction.

current date and time as calculated from GPS satellites. The date and time formats may be changed through the system setup softkey (see Section 9), and the time may be set to display either UTC (Greenwich Mean Time) time or the local time, based on a local offset entered in the system setup menu.

The Highway Page's graphic highway display occupies the majority of the screen, starting at the upper left corner.

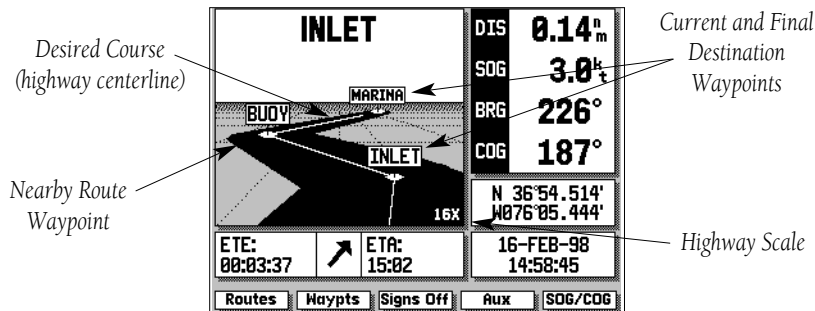

The highway display provides visual guidance to the destination waypoint and keeps you on your intended course line. Your course is represented by the center line down the middle of the graphic highway. As you head toward your destination, the highway perspective will change to indicate your progress to the waypoint and which direction you should steer to stay on course. If the highway moves off to one side, simply steer toward the highway to return to course. When navigating a route, the highway display will show each route waypoint in sequence. Nearby waypoints not in the route will also be displayed. You can zoom in or out on the highway display (through five available settings) for a smaller or larger view.

To zoom in or out on the highway display:

1. Press the down arrow on **ZOOM** to show a smaller view area.
2. Press the up arrow on **ZOOM** to show a larger view area.

The last page in the main sequence is the Active Route Page. The Active Route Page shows each waypoint of the active route (in order), with the waypoint name, desired track, cumulative distance and ETE or ETA for each waypoint from the present position. Your current destination waypoint, the 'active to' waypoint, is marked with an arrow icon, and will be the first waypoint listed. As you navigate a route, the waypoint list will automatically update to display the next 'active to' waypoint first, followed by the remaining route waypoints in sequence.

'Active To'
Route
Waypoint

Route
Waypoint
List

Active Route				
Waypoint	Type	Dsrd Trk	Distance	ETE
➔ INLET	○	207°	0.13 ⁿ m	00:03:33
4 BUOY	!	142°	0.63 ⁿ m	00:17:27
5 MARINA	⚓	216°	2.03 ⁿ m	00:56:19
6	○	°	--- ⁿ m	---
7	○	°	--- ⁿ m	---
8	○	°	--- ⁿ m	---
9	○	°	--- ⁿ m	---
10	○	°	--- ⁿ m	---

Use cursor to review route

Routes Waypts Map Cfg Aux Delete

Cumulative
ETE/ETA
Along Route

Cumulative
Distance
Along Route

From the Active Route Page, you can:

1. Scroll through the entire list of route waypoints using the **▲** keypad.
2. Review the waypoint data for a highlighted waypoint by pressing the **ENT** key.
3. Go directly to a highlighted waypoint by pressing the **GOTO** key.
4. Stop navigation of the Active Route by pressing the **DELETE** softkey.
5. Change the ETE field to display ETA by pressing the **DATA** key.

Active Route			ETE
Waypoint Review Waypoint			
➔ INLET	○		00:03:34
4 BUOY	!	N 36°54.401'	00:18:37
5 MARINA	⚓	W076°05.547'	01:00:43
6	○	Ref Wpt: ---	---
7	○	Brg: ° Dis: --- ⁿ m	---
8	○		---
9	○	CRTD 13:58 16-FEB-98	---
10	○		---

Press ENT to confirm

Scan Rename Del Wpt OK Exit

Reviewing a Route Waypoint

Active Route				
Waypoint	Type	Dsrd Trk	Distance	ETE
➔ INLET	○	207°	0.10 ⁿ m	00:04:22
4 BUOY	!	142°	0.60 ⁿ m	00:26:22
5 MARINA	⚓			01:27:55
6	○	°	--- ⁿ m	---
7	○	°	--- ⁿ m	---
8	○	°	--- ⁿ m	---
9	○	°	--- ⁿ m	---
10	○	°	--- ⁿ m	---

Are You Sure? YES NO

Use cursor to highlight choice, ENT to accept

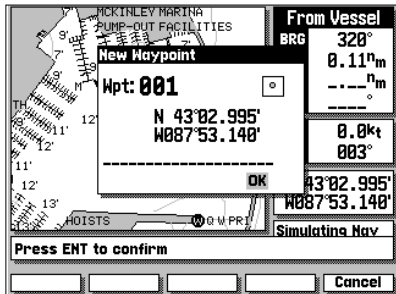
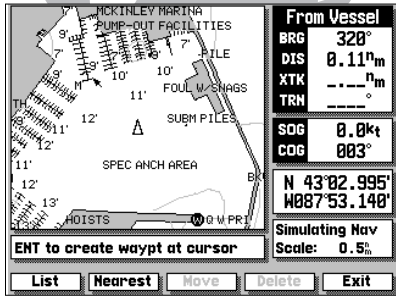

Cancel

Deleting the Active Route



The GARMIN GPSMAP system stores over 1900 alphanumeric waypoints with a user-defined icon and comment available for each waypoint. Waypoints can be created, reviewed, moved or deleted right from the Map Page using the target cursor to select positions and waypoints, and are managed through the WAYPOINTS softkey. Once you are in the waypoint mode, you can also create, edit and review waypoints through the waypoints list and the nearest waypoints windows. Let's cover the graphic waypoint functions first.

To create a waypoint from the map display:





1. Press the WAYPTS softkey. The target cursor will appear as an arrow pointer.
2. Use the  keypad to move the arrow cursor to the desired waypoint position.
3. Press the  key to capture the position.

The New Waypoint window will appear, with a default three-digit name and graphic icon. The position coordinates are displayed in the center of the window, with a user-defined comment field below.

4. To accept the default waypoint name, icon and comment (the date and time of creation), press the  key to confirm the 'OK' prompt.

The GPSMAP system lets you enter your own six character waypoint name, a 20-character user comment and a graphic icon for each waypoint.

To enter a user-defined name, icon or comment:

1. Highlight the name, icon or comment field and press .
2. Use the  keypad to enter a name, icon or comment and press the OK softkey (for name and comment entry) or the  key (for icon selection).
3. After you've made your changes, highlight the OK prompt and press .

Other graphic waypoint functions include reviewing and modifying on-screen waypoints. By moving the cursor close to an on-screen waypoint, you can “snap” to a specific waypoint. Once the target cursor snaps to a waypoint, the waypoint will be highlighted with a white circle, and the GPSMAP will display waypoint information in the data window at the bottom right corner of the screen. When an on-screen waypoint is highlighted, you’ll be able to review, edit, move or delete the waypoint.

To select and review an on-screen waypoint:

1. Use the **ENT** keypad to ‘snap to’ the on-screen waypoint.
2. Press **ENT** to display the Review Waypoint window for the highlighted waypoint.

From the Waypoint Review window, you can change the waypoint name, icon or comment, edit the position coordinates, or delete the waypoint. You can also determine the distance and bearing from the displayed waypoint to any other waypoint stored in your GPSMAP system.

To change the waypoint icon, comment or position:

1. Highlight the icon, comment, or position field and press **ENT**.
2. Use the **ENT** keypad to enter the new icon, comment or position and press the OK softkey (for name and comment entry) or the **ENT** key (for icon selection).
3. After you’ve made your changes, highlight the ‘OK’ prompt and press **ENT**.

To change the waypoint name or delete the waypoint from memory:

1. To rename the waypoint, press the RENAME softkey, use the **ENT** keypad to enter the new waypoint name, and press the OK softkey when finished.
2. To delete the waypoint, press the DEL WPT softkey and **ENT** to confirm.

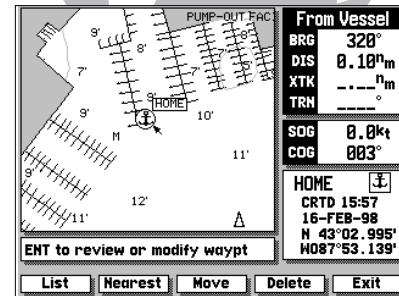

Data for the selected waypoint or navaid is displayed at the bottom right corner of screen.

Note:

‘Active to’ destination waypoints cannot be deleted from system memory until the active GOTO or route has been cancelled.

To cancel an active GOTO, press the **GOTO** key, then press the CLR GOTO softkey.

To cancel an active route, press the ROUTES softkey, highlight route 0, then press the DELETE softkey.

SECTION

WAYPOINTS

5

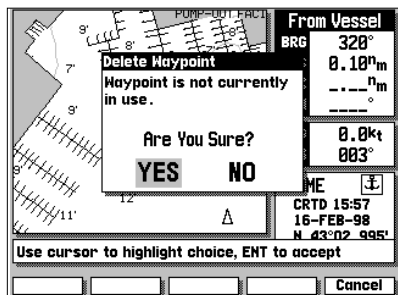
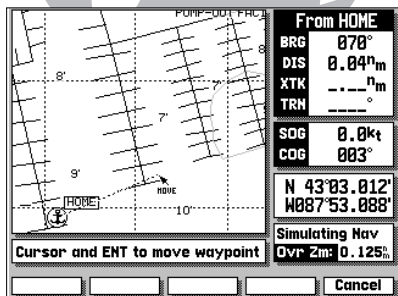
Moving & Deleting
Waypoints Graphically

The last two graphic waypoint functions allow you to move a highlighted on-screen waypoint or delete it from system memory using the map display.

To move an on-screen waypoint:

1. Use the keypad to 'snap to' the on-screen waypoint.
2. Press the MOVE softkey.
3. Use the keypad to move the arrow cursor to the new waypoint position. As you move the arrow cursor, the bearing and distance from the original waypoint position will be displayed at the top of the data window, with the position coordinates of the new position displayed in the position field.
4. Press the key to confirm the move.





To delete an on-screen waypoint:

1. Use the keypad to 'snap to' the on-screen waypoint.
2. Press the DELETE softkey.
3. Press the key to confirm the deletion warning.

The WAYPOINTS softkey also provides access to the GPSMAP system's waypoint management features, the waypoints list and nearest waypoints list. To access the waypoint and nearest lists, press the WAYPOINTS softkey from any GPSMAP page.



The waypoints list functions allow you to scroll through a master list of all stored waypoints for review or editing, delete individual waypoints or delete all stored waypoints, and create new waypoints through a text window. The waypoint list will list over 1900 stored waypoints in numerical to alphabetical order, with the waypoint icon and comment shown for each listing.

To scroll through and review the waypoint list:



1. Press the WAYPTS softkey (if you are not currently in the waypoints submenu).
2. Press the LIST softkey.
3. Use the  keypad to scroll through the list in either direction.
4. Press the  key to review the highlighted waypoint.
5. Highlight the OK prompt and press  to return to the waypoint list.
6. The field highlight will automatically scroll to the next waypoint. If you want to see the review waypoint window for each listing, you can also scroll through any waypoint list by pressing the  key repeatedly.









Once the waypoint review window is displayed, you may change any data field, rename or delete the waypoint by following the steps outlined on page 29. You can also delete an individual waypoint or the entire list of waypoints right from the waypoint list.

To delete an individual waypoint from the list:

1. Use the  keypad to highlight the waypoint to be deleted.
2. Press the DELETE softkey.
3. Press the  key to confirm the deletion warning.



To delete the entire list of waypoints:

1. Press the DEL ALL softkey.
2. Press the  keypad to highlight the 'YES' prompt.
3. Press the  key to confirm the deletion.

Waypoint	Type	Description
005		CRTD 15:07 16-FEB-98
006		CRTD 14:22 16-FEB-98
BUOY		CRTD 10:00 16-FEB-98
DAY1		CRTD 17:30 16-FEB-98
FISH		CRTD 11:15 15-FEB-98
GIG		CRTD 15:03 16-FEB-98
HOME		CRTD 15:57 16-FEB-98
INLET		CRTD 19:01 16-FEB-98
MARINA		CRTD 15:03 16-FEB-98

Press ENT to review or modify

Create Delete Del All Exit

Once a waypoint on the waypoint list is highlighted, you can select it as a GOTO destination right from the list by pressing the  key, followed by .

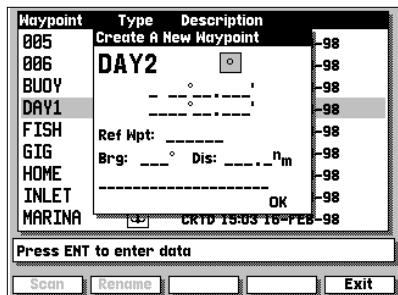
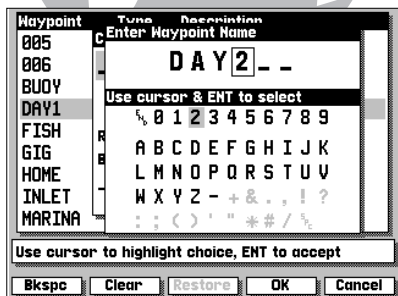

The CREATE softkey lets you create new waypoints by entering a name and position, or by entering the distance and bearing from an existing (reference) waypoint.

To create a new waypoint from the list submenu:

1. If the waypoints list isn't currently displayed, select it by pressing the WAYPTS softkey, followed by the LIST softkey.
2. Press the CREATE softkey.
3. Use the **0** keypad to enter the new waypoint name.
4. Press the OK softkey to confirm the name.
5. The Create a New Waypoint window will appear, with the icon field highlighted. To select an icon for your waypoint, press **ENT** and use the **0** keypad to choose the icon. Press the **ENT** key to confirm the selection.
6. To enter the position coordinates of the new waypoint, highlight the position field and press **ENT**. Use the **0** keypad to enter the position, and press **ENT** to confirm the entry.
7. To accept the new waypoint with the default comment (the date and time of creation), press **ENT**. To enter your own comment, highlight the comment field and press the **ENT** key. Use the **0** keypad to enter the comment and press the OK softkey to confirm your entry.
8. When you have finished entering all your waypoint data, use the **0** keypad to highlight the OK prompt and press the **ENT** key.

If you don't know the position coordinates for your new waypoint, you can enter the distance and bearing from a reference waypoint (any waypoint stored in memory), and the GPSMAP will calculate the coordinates for you.

To create a new waypoint using a reference waypoint:

1. Follow steps 1-5 (on page 32) for creating a new waypoint.
2. Highlight the reference waypoint field and press the SCAN softkey.
3. Use the  keypad to scan the waypoint list and find the desired reference waypoint. Press **ENT** to confirm the reference waypoint.
4. Press **ENT** to begin entry of the bearing from your reference waypoint to the new waypoint position. Enter the bearing and press **ENT**.
5. Press **ENT** to begin entry of the distance from your reference waypoint to the new waypoint position. Enter the distance and press **ENT**. The position for the new waypoint will automatically be calculated for you.
6. Press the **ENT** key to confirm the OK prompt.

The last softkey function under the waypoints softkey is the nearest waypoints function. The NEAREST softkey will display a list of the nine nearest waypoints within 100 nautical miles of your present position, with the waypoint name, icon, distance and bearing displayed.

To scroll through and review the nearest waypoint list:

1. Press the WAYPTS softkey (if you are not currently in the waypoints submenu).
2. Press the NEAREST softkey.
3. Use the  keypad to scroll through the list in either direction.
4. Press the **ENT** key to review the highlighted waypoint.
5. Highlight the OK prompt and press **ENT** to return to the waypoint list.
6. If you want to see the review waypoint window for each listing, you can also scroll through the entire list by pressing the **ENT** key repeatedly.

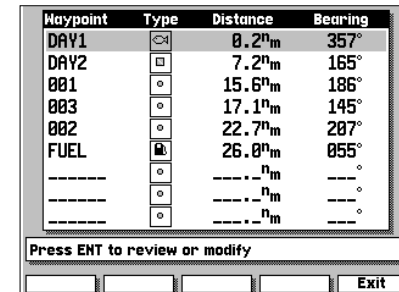
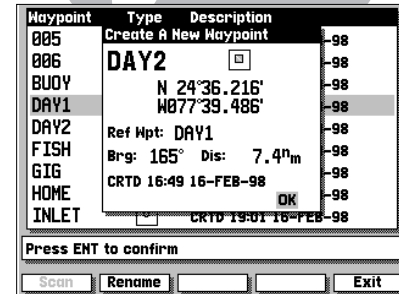

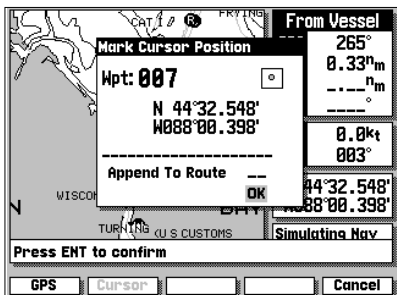
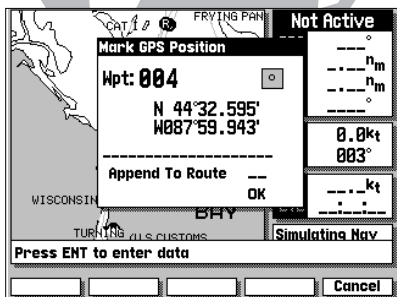

The GARMIN GPSMAP system features a **MARK** key that lets you quickly capture your present position or a target cursor position and create a new waypoint right from the map display. The **MARK** key will capture your present position when the cursor is not in use, or will give you the option of marking your present position or the cursor position when the cursor is in use.

To mark your present position:

1. Press the **MARK** key to capture your present position.
2. If you want to accept the waypoint with the default name, symbol and comment, press **ENT** to confirm the 'OK' prompt.
3. To enter your own name, symbol or comment, highlight the appropriate field and press **ENT**.
4. After entering your changes, using the **ROV** keypad, move the field highlight back to the 'OK' prompt and press **ENT**.

To mark the cursor position:

1. Use the **ROV** keypad to move the cursor to the desired position.
2. Press the **MARK** key to mark the position.
3. Press the **CURSOR** softkey to use the Cursor Position.
4. If you want to accept the waypoint with the default name, symbol and comment, press **ENT** to confirm the 'OK' prompt.
5. After entering your changes, using the **ROV** keypad, move the field highlight back to the 'OK' prompt and press **ENT**.

The cursor may also be used to mark a navaid position as a waypoint by pointing to the desired navaid with the cursor, following the steps above, and selecting the **NAVAID** softkey (in lieu of the **CURSOR** softkey). The default comment will be the navaid text shown on the Map Page.

The GPSMAP's GOTO command lets you select any stored waypoint or target cursor position as a destination and quickly set a course from your present position. Once a GOTO has been activated, the Highway Page will provide steering guidance to your destination. A GOTO may be activated on the map display using the cursor, or from any waypoint list.

To activate a GOTO from the map display:

1. Press the **GOTO** key.

The cursor will appear as an arrow pointer, which lets you point to a position as your destination using the **ENT** keypad. If you want to GOTO an existing on-screen waypoint, 'snap to' the waypoint with the arrow pointer and press the **ENT** key. If your destination is not an existing waypoint or is an on-screen navaid, you'll need to mark the position as a waypoint:

2. Press the **ENT** key to confirm the arrow pointer position as your destination.
3. If you want to accept the new GOTO waypoint with the default name, symbol and comment, press **ENT** to confirm the 'OK' prompt.
4. To enter your own name, symbol or comment, highlight the appropriate field and press **ENT**. After entering your changes, move the field highlight back to the 'OK' prompt and press **ENT**.

You can also quickly activate a GOTO to any stored waypoint from any waypoint list (e.g. the waypoint list or nearest waypoints list).

To activate a GOTO from a waypoint list:

1. Highlight the desired waypoint with the **ENT** keypad.
2. Press **GOTO** key to activate the GOTO mode.
3. Press **ENT** to confirm the new GOTO waypoint.

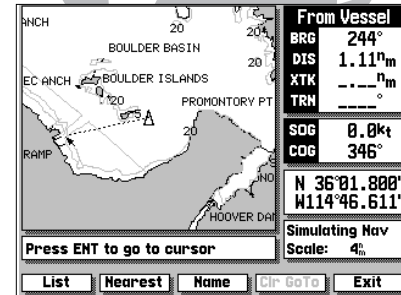

Cursor GOTO

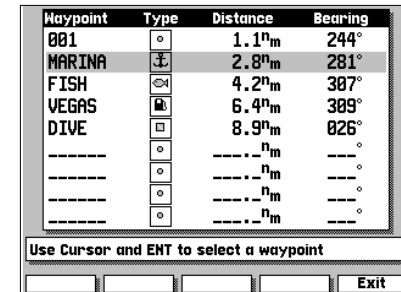

List GOTO

SECTION

GOTO/MOB

7

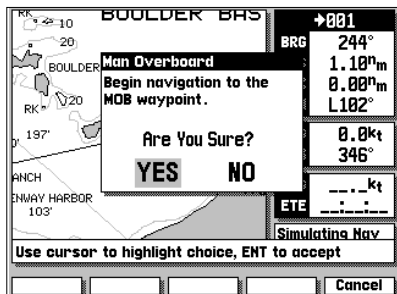
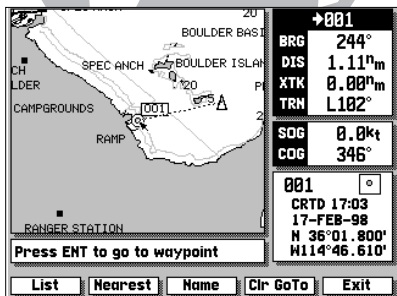
Stopping Active GOTOs
MOB Function

Once a GOTO has been activated, the GPSMAP will keep the waypoint as your active destination and provide steering guidance until you stop the active GOTO.

To stop navigating to an active GOTO position:

1. Press the **GOTO** key.
2. Press the CLR GOTO softkey.

The GPSMAP's man overboard function (MOB) lets you mark and set an immediate course to a position for quick response to emergency situations.

To activate the MOB function:

1. Press the **MOB** key.
2. Press the **ENT** key to confirm that you want to stop any current route or GOTO navigation and begin navigating to the MOB position.
3. If you only want to mark the MOB position, and do not want to make the MOB position the active destination waypoint, use the **NO** keypad to highlight the 'NO' prompt and press the **ENT** key.

Once an MOB has been activated, an MOB icon will appear on the map display, and the destination field on the Map Page will display the bearing, distance, XTK and ETE to the MOB position based on your present speed and course. To view highway display steering guidance to the MOB position, press the **PAGE** key to display the Highway Page.

To stop navigating to the MOB position:

1. Press the **GOTO** key.
2. Press the CLR GOTO softkey.

The GARMIN GPSMAP system lets you create and store up to 20 reversible routes with up to 50 waypoints each. Routes can be created and modified right from the Map Page, allowing you to see each route graphically on-screen as you create, review, modify or navigate the route. The GARMIN route system is a powerful and extremely flexible system that you'll want to master to get the most out of your GPSMAP system.

Rte	Start	→ End	Description
0	---	→	-----
1	DAY1	→ 002	DOCK TO BAY
2	PT2	→ HARBOR	GIG HARBOR TRIP
3	FISH	→ MARINA	LVNHAVEN TRIP
4	---	→	-----
5	---	→	-----
6	---	→	-----
7	---	→	-----
8	---	→	-----

Press ENT to review or modify

Active Invert Copy Rte Delete Exit

Rte	Start	→ End	Description
0	PT2	→ HARBOR	GIG HARBOR TRIP
1	DAY1	→ 002	DOCK TO BAY
2	PT2	→ HARBOR	GIG HARBOR TRIP
3	FISH	→ MARINA	LVNHAVEN TRIP
4	---	→	-----
5	---	→	-----
6	---	→	-----
7	---	→	-----
8	---	→	-----

Press ENT to review or modify

Active Invert Copy Rte Delete Exit

When a route is activated or inverted, it is copied into Route 0. The original route remains intact in its original storage route.

Each route in the GPSMAP system has its own route number. Routes 1 through 19 are used as storage routes, with Route 0 always serving as the active route you are navigating. When you activate a route, the storage route you are activating is simply copied into Route 0, the active route.

This feature lets you modify your active route while you navigate, without changing the storage route you activated. When you are finished navigating the active route, simply delete Route 0 by pressing the DELETE softkey (you still have the original route in storage) to stop navigating the active route. To store a modified Active Route, copy Route 0 to an empty storage route.

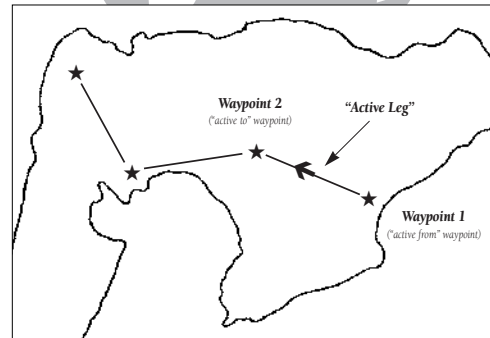

Routes are broken down and navigated in smaller segments called 'legs'. The waypoint you are going to in a leg is called the 'active to' waypoint, and the waypoint immediately behind you is called the 'active from' waypoint. The line connecting the 'active to' and 'active from' waypoint is referred to as the 'active leg'.

When a route is activated in the GPSMAP system, the route leg closest to your position is automatically selected as the 'active leg'.

SECTION

8

ROUTES

Creating Routes
Graphically

Rte	Start	→ End	Description
0	-----	→	-----
1	DAY1	→ 002	DOCK TO BAY
2	PT2	→ HARBOR	GIG HARBOR TRIP
3	FISH	→ MARINA	LYNNHAVEN TRIP
4	-----	→	-----
5	-----	→	-----
6	-----	→	-----
7	-----	→	-----
8	-----	→	-----

Press ENT to create a new route

Activate Invert Copy Rte Delete Exit

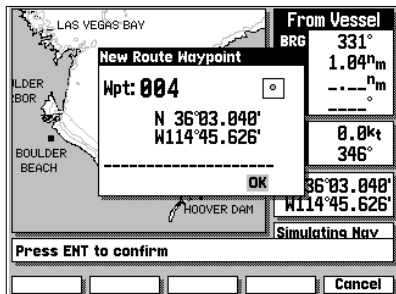

All of the GPSMAP route functions are accessed through the ROUTES softkey, located at the far left of the softkey menu.

To create a route from the map display:

1. Press the ROUTES softkey to display the route list window.
2. Use the keypad to select an empty storage route (routes 1-19) and press the key. You can create a route in the active route (Route 0) position, but you'll need to copy it to an empty storage route to save it, as it will be overwritten by the next route activation.
3. The route list window will be replaced by the Map Page, with the target cursor appearing as an arrow pointer. To add waypoints to the route, use the keypad to move the arrow cursor to the desired position and press the key.

HINT: Once the map display is in route creation mode, you can use the arrow cursor to 'snap to' existing on-screen waypoints or nav aids, or create new waypoint positions. Existing waypoint positions will be added to the route without confirmation. Whenever you are adding a new route waypoint not currently stored in memory, you'll be asked to save the new waypoint.

4. Press to confirm the 'OK' prompt.
5. Once you've entered all the desired route waypoints, press the EXIT softkey.

The map display will now return to the map review mode, where you can review, activate, invert or modify the current on-screen route. The review mode will always appear when you have finished creating a new route on the map display or when you have selected an existing route for review from the route list window.

When the review mode is in use, the cursor may be used to highlight individual route legs. When a route leg is highlighted, the ‘active from’ and ‘active to’ waypoints will be displayed at the bottom of the data window, with the desired track (DTK) and distance (DIS) for the leg indicated below. The rest of the map review functions are performed through the map review softkeys at the bottom of the screen.

To activate or invert the on-screen route:

1. Press the ACTIVATE softkey.
2. To invert (activate in reverse order) the route, press the INVERT softkey.

Once a route has been activated or inverted, the destination field in the data window will display navigation information to the next ‘active to waypoint’. As you complete navigation of each route leg, this information will be updated to reflect the next ‘active to’ waypoint in the route. When you reach the final destination waypoint in the active route, you’ll need to cancel the active route to stop navigation to the last route waypoint. Also note that the Active Route, if not cancelled, will be automatically reactivated when the unit is powered up.

To stop navigation of the active route:

1. Press the ROUTES softkey.
2. Press the DELETE softkey.
3. Press the **ENT** key to confirm the delete route warning.

To save a newly created or modified Active Route, copy Route 0 to an open storage route (Routes 1-19), as the Active Route will be overwritten by any new route activation.

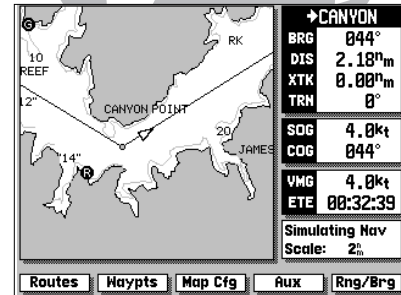

Activated Routes appear as solid lines.

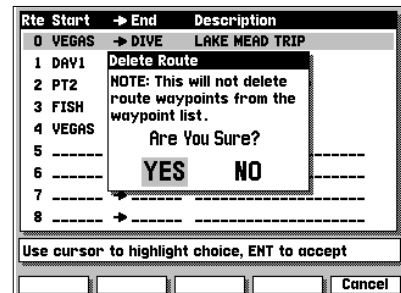

SECTION

8

ROUTES

Modifying Routes Moving Route Waypoints

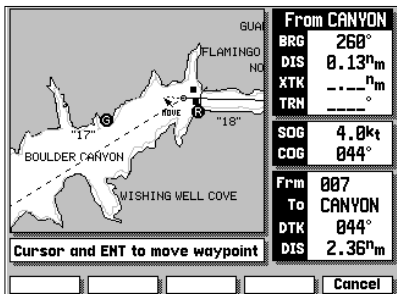
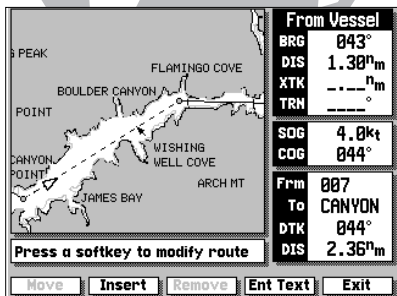

The next softkey in the route review mode allows you to modify a route by moving, inserting or removing route waypoints on screen or editing a route through a text review window.



To modify the on-screen route:

1. Select the route review mode for the desired route, as described on page 38.
2. Press the MODIFY softkey.

Once you have pressed the MODIFY softkey, you'll notice that you have a new set of softkeys below the map display:

- The MOVE softkey allows you to move the position of any route waypoint on screen.
- The INSERT softkey will let you add a new route waypoint before the first route waypoint, add a new route waypoint after the last route waypoint or add a new waypoint anywhere in between.
- The REMOVE softkey will let you delete any waypoint from the route and adjusts the route legs accordingly.
- The ENT TEXT softkey provides an editing window to add a comment; review, insert or remove waypoints; or activate/invert the route.
- The EXIT softkey returns you to the route review mode.

To move an on-screen waypoint:

1. Use the  keypad to snap to the waypoint you want to move.
2. Press the MOVE softkey.
3. Use the  keypad to move the arrow cursor to the new waypoint position.
4. Press the **ENT** key to complete the move.

The INSERT softkey allows you to add a waypoint before the first route waypoint or after the last route waypoint; or add a new route waypoint to an existing route leg.

To insert a new starting or ending route waypoint:

1. Use the **ENT** keypad to snap to and highlight the first or last route waypoint.
2. Press the INSERT softkey.
3. Use the **ENT** keypad to move the arrow cursor to the new waypoint position.
4. If the new waypoint position is not an existing waypoint, confirm the New Route Waypoint by highlighting the 'OK' prompt and pressing the **ENT** key.
5. Press the **ENT** key to complete the insertion.
6. Press the EXIT softkey to return to the route modification mode.

To insert a new waypoint in an existing route leg:

1. Use the **ENT** keypad to snap to and highlight a route leg.
2. Press the INSERT softkey.
3. Use the **ENT** keypad to move the arrow cursor to the new waypoint position.
4. If the new waypoint position is not an existing waypoint, confirm the New Route Waypoint by highlighting the 'OK' prompt and pressing the **ENT** key.
5. Press the **ENT** key to complete the waypoint insertion. Two route legs (one going to the new waypoint and another from the new waypoint) will now replace the original single route leg.

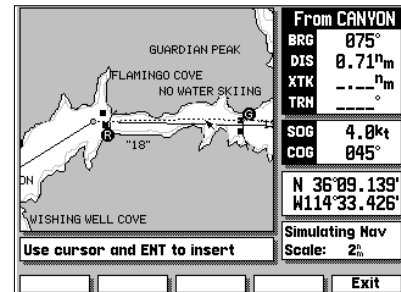
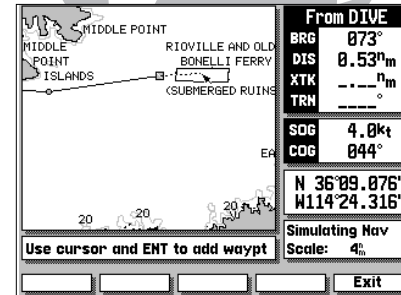

SECTION

8

ROUTES

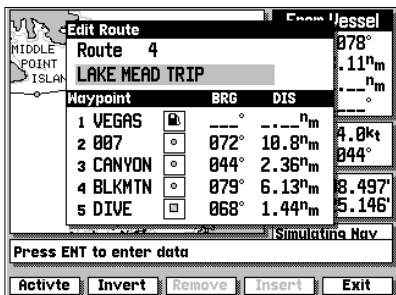
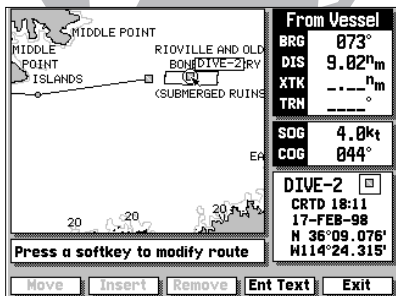
Removing Waypoints
Route Comments**To remove a route waypoint:**

1. Use the **ENT** keypad to snap to and highlight the waypoint you want to remove.
2. Press the REMOVE softkey.

The ENT TEXT softkey will display a text editing window where you may add a route comment, insert or delete waypoints or review any waypoint of the on-screen route. You can also activate or invert the route using the ACTIVTE or INVERT softkeys available from the Edit Route window.

To display the Edit Route window:

1. Press the ENT TEXT softkey.

The Edit Route window will appear with the route comment field highlighted. The waypoint list shows the route waypoints in sequence, with the waypoint name, symbol, and bearing and distance between waypoints indicated.

To enter a route comment:

1. Highlight the comment field and press the **ENT** key.
2. Use the **ENT** keypad to enter your comment.
3. Press the OK softkey to accept the comment.
4. Press the EXIT softkey to return to the modify mode.
5. Press the EXIT softkey again to return to the route review mode.

You can also quickly access the Edit Route window and add a route comment after a route has been created by pressing the TXT RVW softkey from the route review mode.

The Edit Route window will also let you scroll through the list of route waypoints, review each waypoint, and change waypoint information.

To review a route waypoint:

1. Select the Edit Route window using either method described on page 42.
2. Use the **▲** keypad to scroll through and select the waypoint to be reviewed.
3. Press the **ENT** key to display additional information for the selected waypoint.
4. Press the OK softkey to return to the Edit Route window. The field highlight will automatically scroll to the next route waypoint on the list.

With the additional waypoint information displayed (on the Select Route Waypoint window), you may change the name, symbol, position or comment by highlighting the appropriate field and entering new information. You can also replace any route waypoint with an existing or entirely new waypoint.

To replace a route waypoint with another stored waypoint:

1. Use the **▲** keypad to highlight the waypoint name field.
2. Press the SCAN softkey.
3. Use the **▲** keypad to scan the waypoint list and select a new waypoint.
4. Press **ENT** to return the cursor to the OK prompt.
5. Press **ENT** to confirm the replacement waypoint.

To replace a route waypoint with a new waypoint:

1. Use the **▲** keypad to highlight the waypoint name field.
2. Press the **ENT** key and use the **▲** keypad to enter the new waypoint name.
3. Enter the waypoint position (and any other data) and press the OK softkey.

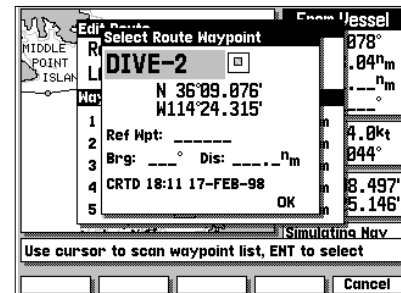
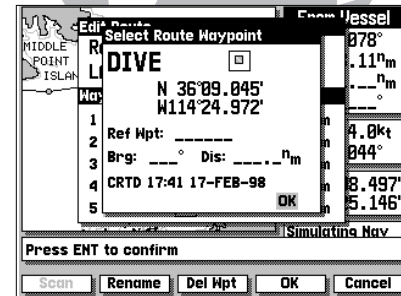

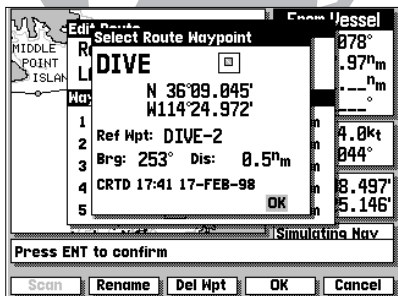

From the Select Route Waypoint window, you can also determine the distance and bearing between the route waypoint shown and any other waypoint in memory.

To use the reference waypoint function:

- Highlight the 'Ref Wpt' field
- Press the SCAN softkey
- Use the **▲** keypad to scroll through and find the desired waypoint

The distance and bearing will now be displayed below the reference waypoint field.

The Select Route Waypoint window also lets you rename a route waypoint, or delete a waypoint from system memory ('active to' waypoints cannot be deleted).

To rename a route waypoint:

1. Press the RENAME softkey.
2. Use the **▲** keypad to enter the new name.
3. Press the OK softkey to accept the new waypoint name.

To delete a route waypoint from system memory:

1. Press the DEL WPT softkey.
2. Press the **ENT** key to confirm the delete waypoint warning.

The last two functions of the Edit Route window (described on pages 42-43) are removing and inserting route waypoints from the route waypoint list.

To remove a route waypoint from the list:

1. Using the **▲** keypad, highlight the waypoint you want to remove from the route.
2. Press the REMOVE softkey.

To insert a route waypoint in the list:

1. Use the **▲** keypad to highlight the existing route waypoint position where you want the new waypoint to appear.
2. Press the INSERT softkey.
3. To insert a waypoint from the main waypoint list, press the SCAN softkey, use the **▲** keypad to select a waypoint and press the **ENT** key twice.
4. To enter a new waypoint, press the **ENT** key, use the **▲** keypad to enter the new waypoint name and press the OK softkey.
5. Enter the waypoint position and data and press the OK softkey.

In addition to the graphic on-screen creation of routes, the GPSMAP system also provides a data entry window for creating new routes.

To create a route through data entry:

1. Press the ROUTES softkey to display the route list window.
2. Use the **0** keypad to select an empty route and press the **ENT** key.
3. Press the TEXT CRT softkey to display the Edit Route window.

The Edit Route window will appear, with the comment field highlighted.

To enter a route comment:

1. Press the **ENT** key with the comment field highlighted.
2. Use the **0** key to enter your comment and press the OK softkey when finished.

The field highlight will move to the first route waypoint field, where you may select each waypoint of the new route by scanning your existing waypoint list or entering new waypoints.

To add existing (or new) waypoints to a route:

1. Highlight the route waypoint field (waypoints must be added in route sequence).
2. Press the **ENT** key to begin entry.
3. Press the SCAN softkey.
4. Use the **0** keypad to scan the waypoint list and select the route waypoint.
5. Press the **ENT** key twice to confirm the selection.
6. Repeat the above steps to add each additional route waypoint.
7. To add a new waypoint to the route, follow steps 1 and 2 above, then press the **ENT** key to begin entry of waypoint data. After you've entered the name, position and other information, confirm the OK prompt by pressing **ENT**.

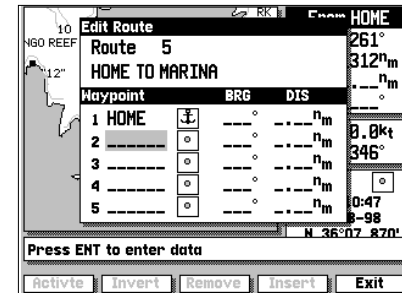



The GPSMAP's AUX softkey provides access to the various system, navigation and interface setup menus used to customize your unit's operation. Once you have pressed the AUX softkey, you'll see a complete list of available options listed by category. Each category on the list has its own submenu of setup options and functions which can be accessed by selecting an Auxiliary Menu option with the **ENT** keypad and pressing **ENT**. Available options are:

System Setup	Settings for operating mode, date/time format, enable/disable audio tone, screen contrast adjustment
Navigation Setup	Position format; units of measure for distance, speed and depth; heading reference; Settings for map datum and map orientation
Timer/Alarm Setup	Timers for count down and elapsed time; Alarms for clock time, anchor drag, waypoint proximity and off course
Interface Setup	Input/output interface settings, beacon receiver frequency/bit rate
Proximity Waypoints	List of any designated proximity waypoints along with on-screen symbol and proximity distance, also create new proximity wpts
Route Trip Planning	Planning window providing route calculations for desired track, distance between waypoints, total fuel required and time enroute
Point-to-Point Planning	Planning window to calculate trip distance, fuel usage, time enroute and ETA between any two waypoint positions
Sunrise/Sunset Planning	Sunrise/sunset times calculated for any waypoint position
Track Recording	Enable/disable recording, settings for recording status and interval, options for erasing track memory and enabling TracBack route
Glossary	Listings of basic information/definitions for navigation terms and on-screen abbreviations

When an Auxiliary Menu option is selected and displayed, you'll see a complete listing of available functions, with the current setting for each option indicated. Once you've entered a submenu, you'll use one of two data entry formats to enter most of your setup preferences:

The *option window* provides you with a list of menu choices from which you select your preferences.

To select a menu choice from an options window:

1. Use the **▲** key to highlight an option from the list.
2. Press the **ENT** key to see a list of menu options.
3. Use the **▲** keypad to highlight your choice and press **ENT**.

The *data entry window* is used for settings that require entry of numerical or alphabetical values, and provides a table of values to enter characters.

To enter a value in a data entry window:

1. Use the **▲** keypad to select a character value for each position. Press the **ENT** key to accept the value and move to the next character position.
2. Press the OK softkey to accept the data entry (pressing the **ENT** key after the final character will also accept the data entry).

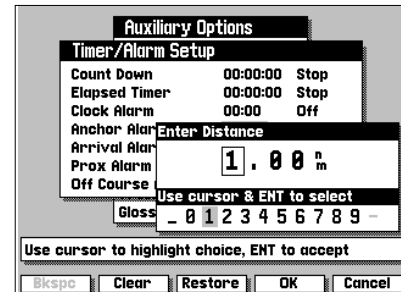
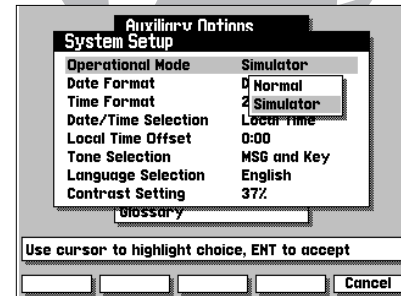

SECTION 9 AUXILIARY MENU

System Setup Options

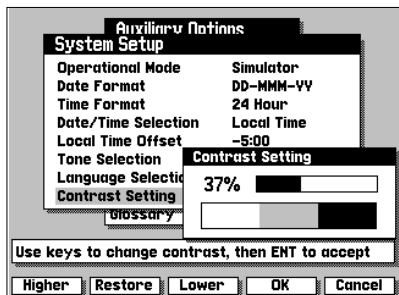
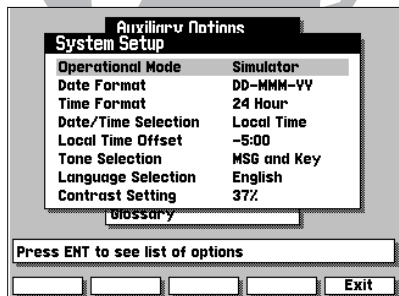

The system setup submenu is used to select the operating mode, date and time formats, tone preferences and display contrast.

Operational Mode lets you select between normal operation and simulator mode. The GPSMAP system does not track satellites in simulator mode, and should not be used for actual navigation. Waypoints and routes created in simulator mode are saved in memory and are available for use in normal mode. While the GPSMAP is acquiring satellites, an AutoLocate™ mode selection is also available.

Date Format selects format between date/month/year and month/date/year.

Time Format allows selection of 12- or 24-hour time display.

Date/Time Selection lets you choose to display the date and time in universal (UTC or Greenwich Mean Time) time or local time offset from UTC time.

Local Time Offset provides a data entry field to enter the time difference between UTC time and the local time. See Appendix E for a list of time offsets. Note that entering an offset will not automatically display local time. The *local time* setting above (under Date/Time Selection) must also be selected.

Tone Selection lets you select an audible tone to sound for messages and key-stroke confirmation, messages only, or not to sound at all. (The tone selection does not affect external alarm operation.)

Contrast Setting provides a slide bar to adjust the LCD screen contrast to compensate for changes in temperature or lighting conditions. Keeping the contrast at the lowest acceptable setting will prolong the life of the display.

To adjust the contrast setting:

1. Use the HIGHER or LOWER softkeys or the  keypad to adjust the contrast.
2. Press the ENT key to confirm the new setting. Pressing the RESTORE softkey before confirmation will restore the previous contrast value.

The navigation setup submenu is used to select a variety of navigation information, including position format, units of measure, and heading preferences. This submenu is also used to select map datums and map display orientation.

Position Format lets you select the coordinate system used to display position. You can select latitude/longitude in three display formats: degrees only (e.g., N37.25818°), degrees and minutes (e.g., N37°15.490) or degrees, minutes and seconds (e.g., N37°15'29.4"). Options are also available for UTM/UPS coordinates, British, Irish, New Zealand or Swiss grids and Loran TDs. For more information on the Loran TD position format, see Appendix H.

Navigation Units selects the format for speed and distance measurements. You may select from nautical, statute or metric formats.

Depth Units selects the format for depth contour display on G-chart™ electronic chart cartridges. Depth contours can be displayed in feet, meters or fathoms. *The default setting is meters.*

Heading lets you select what reference is used in calculating heading information. You can select to reference automatic magnetic variation, true north, grid heading or user magnetic variation. To enter a user magnetic variation:

To enter a user magnetic variation:

1. Select the 'User Mag Var' option and press the **ENT** key.
2. Use the **⬇** keypad to highlight the variation field and press **ENT**.
3. Enter the desired variation and press the OK softkey. Pressing the **ENT** key after entering the final character value will also confirm the entry.

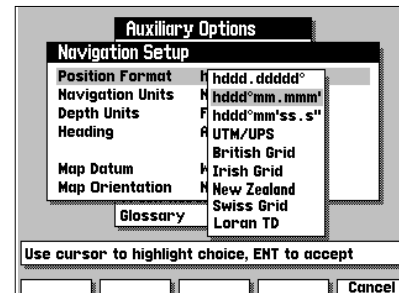
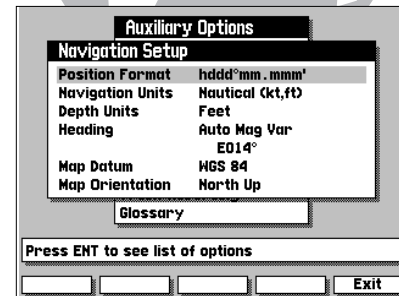

SECTION 9 AUXILIARY MENU

Navigation Setup & Map Settings

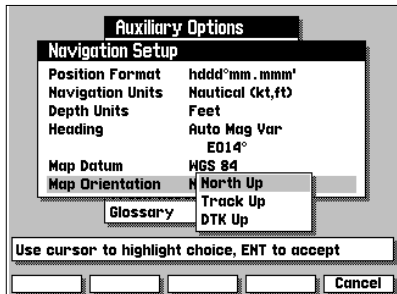
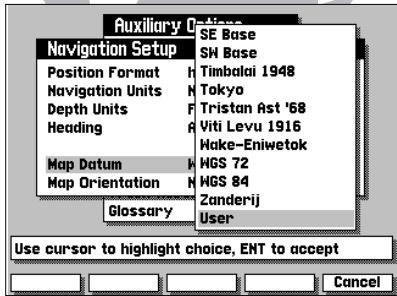

The navigation setup submenu is also used to select map datums and adjust the built-in position and velocity filters. The GPSMAP system's default map datum is WGS 84, a worldwide map datum that's suitable for use with most government charts. You should only change the map datum if the legend on the charts you are currently using specifies a different map datum.



Using an incorrect map datum can seriously effect the accuracy of your GPSMAP navigator. The map datum used on the GPSMAP should always match the datum of the chart you are using. If no datum information is indicated on the charts you are using, contact the chart manufacturer. Selecting and defining a user datum is recommended only for navigators with experience in global models and datums.

Map Datum provides a list of the available map datums for use with the GPSMAP system. For a list of the available GPSMAP datums, see Appendix F. A 'user' datum option is also available to allow entry of your own datum corrections.

To define a user map datum:

1. Select the 'User' option from the datum list.
2. Enter the datum values in each field. The values you enter will be based on their difference from the WGS 84 datum.
3. Highlight the OK prompt and press **ENT** to confirm the user datum.

Map Orientation lets you specify whether the top of the map display remains fixed at north (*North Up*); fixed along your desired course (*DTK Up*); or allow the map display to continually rotate, keeping your current ground track at the top of the display (*Track Up*). When any option other than *North Up* is selected, an indicator will appear on the map display to always show you where north is.

The timer/alarm setup submenu is used to control the GPSMAP's various alarm and timer settings.

Count Down timer controls an alarm to sound when an entered interval (up to 99:59:59) has expired. Enter a time interval in the time field and use the control field to the immediate right to run, stop or reset the timer.

Elapsed Timer provides a running clock to 99:59:59. To run, stop or reset the elapsed time clock, highlight the control field to the right of the timer display, select the appropriate option.

Clock Alarm provides an alarm for the system clock. Enter a time in the time field and turn the alarm on and off from the control field menu. Remember to enter alarm times in the same time format (UTC or local) you're using for your system.

Anchor Alarm lets you specify an alarm to sound when you've exceeded a specified drift distance. Enter a distance up to 9.9 miles or kilometers in the distance field and use the control field to turn the alarm on and off.

Arrival Alarm lets you specify an alarm to sound when you're a specified distance away from a destination waypoint. Enter a distance radius for sounding the alarm and use the control field to turn the alarm on and off. If the arrival alarm is turned off, the alarm will still sound one minute before reaching the destination waypoint at your current speed and course.

Prox Alarm lets you select an alarm to sound when you're a specified distance from a proximity waypoint. Use the control field to turn the alarm on and off. Proximity waypoints and radius values are entered from the proximity waypoint list submenu (see page 56).

Off Course Alarm lets you select an alarm to sound when you're off a desired course by a specified distance. Enter a distance in the distance field and use the control field to turn the off course alarm on and off.

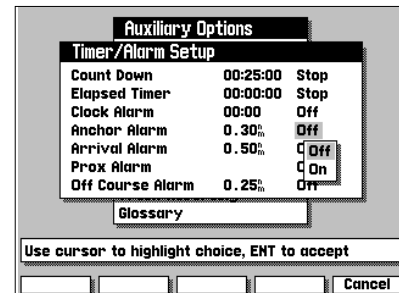
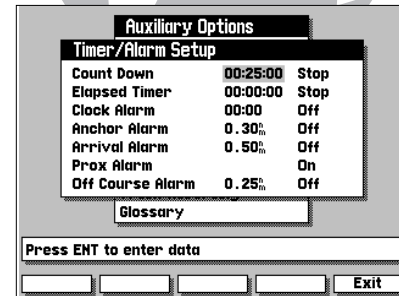

SECTION 9 **AUXILIARY MENU**
Interface Settings
Interface Formats

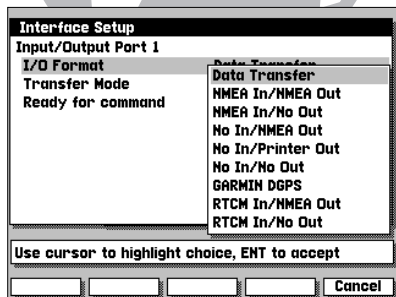

External DGPS unit shown.

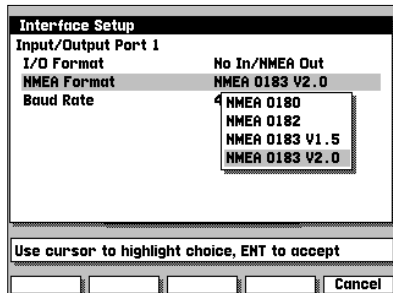

External DGPS unit shown.

The GPSMAP interface setup submenu provides interface settings for connecting external NMEA electronic devices, a PC and/or a differential GPS (DGPS) beacon receiver. The settings, listed at the top of the interface setup window, control a bi-directional I/O port with six (built in DGPS) or nine (optional, external DGPS) available interface formats:

Data Transfer is a proprietary interface that allows you to exchange data such as waypoints, routes and track logs between GPSMAP units or with a PC.

NMEA In/NMEA Out provides navigation information to a compatible NMEA device such as an autopilot or radar, and supports waypoint input from external devices (such as a Yeoman™ Chartplotter) that support waypoint location (WPL) data in an NMEA format. The GPSMAP supports NMEA 0180, 0182, 0183 v.1.5 and 0183 v.2.0 options. See Appendix B for additional NMEA sentence information.

NMEA In/No Out supports waypoint input from external devices (such as a Yeoman™ Chartplotter) that support waypoint location (WPL) data in an NMEA format. The GPSMAP supports NMEA 0183 v.1.5 and 0183 v.2.0 input options.

No In/NMEA Out provides navigation information to a compatible NMEA device such as an autopilot or radar. The GPSMAP provides NMEA 0180, 0182, 0183 v.1.5 and 0183 v.2.0 output options. See Appendix B for additional NMEA sentence information.

No In/Printer Out can output course information to a serial printer. See page 55 for additional instructions.

No In/No Out turns off input and output interface connections.

The interface setup submenu also controls the built-in beacon receiver (if so equipped) or allows you to connect to an external beacon receiver (if purchased without the built-in beacon receiver). When using an external beacon receiver, three additional formats are provided to accept RTCM input corrections:

GARMIN DGPS (external DGPS only) used for connecting your GPSMAP unit with a GARMIN DGPS receiver.

RTCM In/NMEA Out (external DGPS only) provides an input interface for connection of a DGPS beacon receiver and a selectable NMEA output to control tuning functions. With this option selected, additional fields are provided to select a bit rate and frequency for the DGPS beacon site. The DGPS status will be displayed on the Satellite Status Page, with the, signal-to-noise ratio, distance to transmitter and status shown.

RTCM In/No Out (external DGPS only) provides an input interface for connection of a DGPS beacon receiver, but provides no output capabilities. This format is suitable for non-GARMIN automatic or manually-tuned receivers which provide RTCM correction data.

To specify an I/O format, highlight the I/O format field, press **ENT** and select an option from the submenu listing. Once you've selected an I/O format, you may need to specify other preferences in various fields below the format field for transfer modes, NMEA formats, receiver frequency, etc.

When Data Transfer is selected, you'll need to specify what information to request or send to the remote unit or PC through the Transfer Mode field. The *Slave Mode* setting lets you control all data transfer from the connected PC or GPSMAP, while the other settings request or send specific data from the main GPSMAP unit to another Garmin GPS unit.

Whenever an NMEA output is selected for the GPSMAP system, you'll need to select an option from the NMEA Format field. To choose an NMEA format, highlight the NMEA Format field and press **ENT**. Once you've selected a format, the GPSMAP will automatically set the proper baud rate.

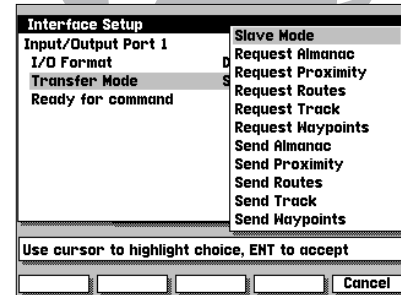

External DGPS unit shown.

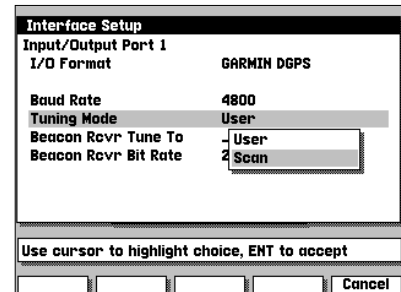

External DGPS unit shown.

Interface Setup	
Input/Output Part 1	
I/O Format	Data Transfer
Transfer Mode	Slave Mode
Ready for command	
Internal Beacon Receiver	
Tuning Mode	User
Beacon Rcvr Tune To	1 User
Beacon Rcvr Bit Rate	2 Scan
Use cursor to highlight choice, ENT to accept	
<input type="button" value="Left"/> <input type="button" value="Right"/> <input type="button" value="Up"/> <input type="button" value="Down"/> <input type="button" value="Cancel"/>	

Internal DGPS unit shown.

Interface Setup	
Input/Output Part 1	
I/O Format	Data Transfer
Transfer Mode	Slave Mode
Ready for command	
Internal Beacon R	
Tuning Mode	3 0 1 . 0 k H z
Beacon Rcvr Tun	Use cursor & ENT to select
Beacon Rcvr Bit	0 1 2 3 4 5 6 7 8 9 -
Use cursor to highlight choice, ENT to accept	
<input type="button" value="Bkspc"/> <input type="button" value="Clear"/> <input type="button" value="Restore"/> <input type="button" value="OK"/> <input type="button" value="Cancel"/>	

Internal DGPS unit shown.

When equipped with a built-in beacon receiver or external DGPS receiver, the GPSMAP system can automatically scan for the DGPS beacon signal or you may manually enter a frequency and bit rate. DGPS status will be displayed on the Satellite Status Page (only when the unit is in 2D or 3D nav mode), along with the, signal-to-noise ratio (SNR) and distance to transmitter (if available).

If your GPSMAP contains an internal DGPS beacon receiver, it is not necessary to select 'GARMIN DGPS' or 'RTCM In/NMEA Out' from the Interface Setup Menu. The GPSMAP will automatically display the frequency and bit rate settings for the beacon receiver at the bottom of the Interface Setup Menu. The DGPS beacon transmitters are operated by the U.S. Coast Guard (or similar government agency in other countries), which is responsible for their accuracy and maintenance. For DGPS transmitter problems or to find the most updated list of frequencies & coverage areas, contact your local USCG, or see their web site at <http://www.navcen.uscg.mil/>.

To have the unit automatically scan for a frequency:

1. With the unit set to 'Garmin DGPS' or 'RTCM In/NMEA Out', use the  key to highlight the "Tuning Mode" field and press **ENT**.
2. Highlight 'Scan' and press **ENT**. The numbers in the "Tune To" and "Bit Rate" Beacon Rcvr fields will change as the unit scans from 284 kHz to 325 kHz 200 bit rate, then 100, at 6-second intervals.

To manually enter a frequency and bit rate:

1. With the unit set to 'Garmin DGPS' or 'RTCM In/NMEA Out', use the  key to highlight the "Tuning Mode" field and press **ENT**.
2. Highlight 'User' and press **ENT**.
3. Highlight the "Tune To" or "Bit Rate" Beacon Rcvr fields, press **ENT**, then enter a frequency or bit rate and press **ENT** when done.

The “Bcn Rcvr” field on the Status Page will show one of the following:

- Tuning— unit is attempting to tune to the specified frequency and bit rate.
- Scanning— unit is automatically scanning through the frequencies and bit rates.
- Receiving— unit is receiving DGPS signal and ready for operation.
- Check Wiring— unit is not making connection with an external DGPS receiver.
- No Signal— unit is not receiving a DGPS signal for the specified frequency.

When the unit is receiving a DGPS signal, the “SNR” (Signal to Noise Ratio) and “Distance” fields will show data. The SNR range is 0dB to 30dB, with 30 being the best. The Distance may or may not show data, depending upon the signal being broadcast from the DGPS site.

No In/Printer Out can output course information to a serial printer.

To enable the serial printer output:

1. Activate the Interface Setup Menu.
2. Using the **▲** key, highlight the *'I/O Format'* field and press **ENT**.
3. Using the **▼** key, select *'No In/Printer Out'* on the selection list and press **ENT**.

The Baud Rate can be set to a range between 300 - 9600.

To change the Baud Rate:

1. Using the **▲** key, highlight the *'Baud Rate'* field and press **ENT**.
2. Using the **▼** key, select the desired baud rate and press **ENT**.

The Output Interval can be set to a time between 3 seconds and 9 hours.

To change the Output Interval:

1. Using the **▲** key, highlight the *'Output Interval'* field and press **ENT**.
2. Using the **▼** key, enter the desired time pressing **ENT** to access the next digit.
3. To accept the new time press **ENT**.

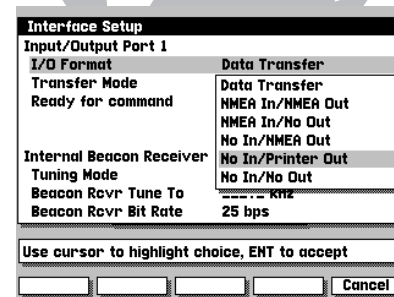

Internal DGPS unit shown.

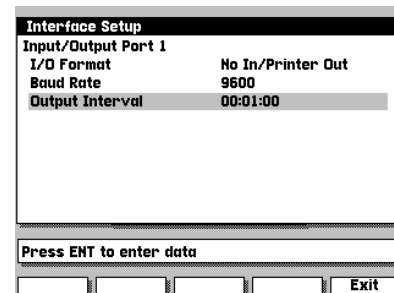

External DGPS unit shown.

Waypoint	Type	Proximity Radius
DIVE		0.5 ⁿ m
FISH		0.2 ⁿ m
ROCKS		1.0 ⁿ m
-----		--- ⁿ m
-----		--- ⁿ m
-----		--- ⁿ m
-----		--- ⁿ m
-----		--- ⁿ m
-----		--- ⁿ m

Press ENT to review or modify

Remove Exit

If a proximity alarm circle overlaps with an existing alarm circle, a 'proximity overlap' warning will be displayed. As long as the overlap exists, the overlap warning will be displayed each time the GPSMAP is turned on.

If you enter an alarm circle overlap, the GPSMAP will only inform you of the closest proximity waypoint.

The next submenu listing on the Auxiliary Menu is the proximity waypoints list. The proximity waypoints list lets you define an alarm circle around a stored waypoint position, and can be used to help you avoid reefs, rocks or restricted waters. Up to nine waypoints may be listed, with a maximum alarm radius of 99.9 nautical or statute miles or kilometers. The alarm is turned on and off through the alarm/timer setup submenu.

To enter a proximity waypoint:

1. Highlight a blank proximity waypoint name field on the list and press **ENT**.
2. Press the **ENT** key to begin manually entering the waypoint name, or
3. Press the SCAN softkey to scan through all waypoints in memory.
4. Use the **▲** keypad to select the desired waypoint and press **ENT**.
5. Press the OK softkey (twice if entering waypoint name manually). The radius field will now be highlighted.
6. Press **ENT** to begin entry of the proximity radius.
7. Use the **▲** keypad to enter a distance value and press **ENT**.

To review a proximity waypoint from the list:

1. Use the **▲** key to highlight the waypoint to be reviewed.
2. Press the **ENT** key.
3. Press the **ENT** key again to return to the proximity list.

To remove a proximity waypoint from the list:

1. Use the **▲** key to highlight the waypoint to be removed.
2. Press the REMOVE softkey.

The GPSMAP system features a route planning window that will calculate and display the desired track and distance to route waypoints, along with the total fuel required and estimated time enroute (ETE).

To use the route planning mode:

1. Highlight the Route Trip Planning option from the Auxiliary Options window and press the **ENT** key.
2. Use the PREV RTE and NEXT RTE softkeys to select a route.
3. Highlight the speed field and enter a speed for your trip.
4. Highlight the fuel flow field and enter a units per hour flow.
5. Highlight the departure date field and enter a date.
6. Highlight the departure time field and enter a departure time.

The starting route waypoint is indicated under the departure date field, with a list of the remaining route waypoints in sequence below. The distance, fuel required and ETE displayed are the total values from the starting waypoint to each listed waypoint, with the desired track representing the course between any two route waypoints.

From the route waypoint list, you can use the **▲** keypad to scroll through the entire list and review individual route legs by highlighting the desired destination waypoint and pressing the **ENT** key.

The Point-To-Point route planning window lets you review leg totals for distance, fuel required and ETE. The estimated time of arrival (ETA), along with the sunrise and sunset at your destination are also displayed. You can use the leg planning window to perform additional speed, fuel and time calculations. To return to the main route planning page, press the EXIT softkey.

Route Planning				
Route	1		Fuel Flow	5.0/hr
Speed	15.0%		Depart Date	18-FEB-98 06:58
Start At	NASSAU			
End At	Dsr'd Trk	Distance	Fuel Rqd'd	ETE
DAY1	235°	25.85%	8.6	01:43:24
001	185°	39.42%	13.1	02:37:40
002	233°	48.83%	16.3	03:15:19
DAY2	075°	68.06%	22.7	04:32:13
----	°	%		----
Press ENT to do leg planning				
Prev Rte	Next Rte			Exit

Route Planning Point-to-Point Planning				
Depart From	NASSAU	Arrive At	DAY1	
Speed	15.0%	Fuel Flow	5.0/hr	
Depart Date	18-FEB-98	Depart Time	06:58	
At Destination:				
Dsr'd Trk	235°	ETA	08:41	
Distance	25.9%	Arrival Date	18-FEB-98	
Fuel Rqd'd	8.6	Sunrise	06:43	
ETE	01:43:24	Sunset	18:07	
Press ENT to review or modify				
				Exit

Auxiliary Options			
Point-to-Point Planning			
Depart From	DAY1	Arrive At	DAY2
Speed	15.0%	Fuel Flow	5.0/hr
Depart Date	18-FEB-98	Depart Time	07:04
At Destination:			
Dsr'd Trk	145°	ETA	08:13
Distance	17.3%	Arrival Date	18-FEB-98
Fuel Rqrd	5.8	Sunrise	06:42
ETE	01:09:05	Sunset	18:06

Glossary

ENT to select waypt, blank plans current position

Remove Exit

Auxiliary Options	
System Setup	
Auxiliary Setup	
Sunrise/Sunset	
Location	DIVE
Date	18-FEB-98
Sunrise	07:23
Sunset	18:21

Sunrise/Sunset Planning
Track Recording
Glossary

ENT to select waypt, blank plans current position

Remove Exit

The GPSMAP's point-to-point planning feature lets you calculate the desired track, trip distance, fuel usage, ETE and ETA between any two waypoints or your present position and a stored waypoint. The planning mode will also provide sunrise and sunset data at your destination on the specified arrival date.

To use the point-to-point planning mode:

1. Highlight the Point-to-Point Planning option and press the **ENT** key.
2. Enter a departure and arrival waypoint in the appropriate fields. Once the Select a Waypoint window appears, use the SCAN softkey to quickly select the desired waypoint from the list. (If you leave the departure or arrival waypoint field blank, your present GPS position will be used for planning calculations.)
3. Enter a speed and hourly fuel flow in the appropriate fields.
4. Enter the departure date and time for your trip.

Once you've entered your speed, fuel and date/time values, the trip information will be calculated and displayed at the bottom of the window.

The GPSMAP's planning features also include a separate Sunrise/Sunset Planning window to provide sunrise and sunset times at any waypoint.

To use the sunrise/sunset function:

1. Highlight the Sunrise/Sunset Planning option and press the **ENT** key.
2. Enter a waypoint in the location field and use the SCAN softkey to quickly select the desired waypoint from the list. (If you leave the waypoint field blank, your present GPS position will be used.)
3. Enter the date you want sunrise and sunset information for in the date field. The default date is always the current date.

The GPSMAP's track recording submenu lets you specify whether or not to record a track plot (an electronic recording of your path) and define how it is recorded. It also provides an indicator of the track memory used, and functions to clear the track memory or create a TracBack route.

Recording Status lets you define how track plot memory will be used:

Off– no track plot will be recorded. (NOTE: Selecting 'Off' will prevent you from using the TracBack feature.)

Fill– a track plot will be recorded until track memory is full.

Wrap (default)– a track plot will be continuously recorded, wrapping through the available memory (replacing the oldest track data with new data).

Recording Interval defines the frequency with which the track plot is recorded:

Time– records track plot based upon a user-defined time interval.

Distance– records track plot based upon a user-defined distance between points.

Resolution– records track plot based upon a user-defined variance from your course over the ground. This setting is recommended for the most efficient use of track memory and TracBack performance. The distance value (entered in the *Interval Value* field) is the maximum left/right deviation allowed from the last defined ground track before recording a new track point.

Interval Value defines the distance or time interval used to record the track plot.

Erase Track Memory lets you clear all track plot data currently stored in memory.

To erase the track plot memory:

1. Highlight the Erase Track Memory field and press **ENT**.
2. Move the field highlight to the 'Yes' prompt and press the **ENT** key.

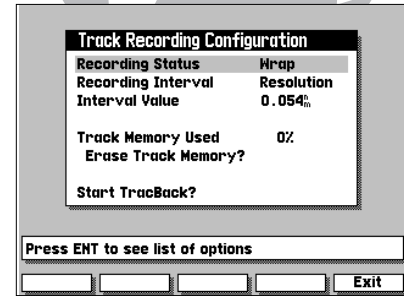

The 'Track Memory Used' field displays the percentage of available memory currently being used. If you are nearing 100% capacity, you can download (and save) the track data to a PC using an optional PC Software kit.

Track plot data may also be converted into a route by using the 'Start TracBack?' option. See page 60 for more information on this feature.

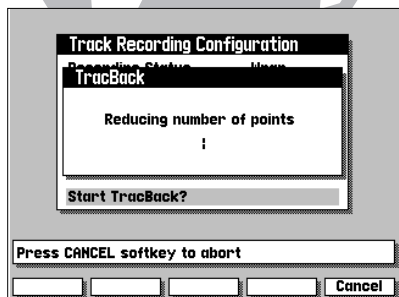

Active Route: TRACBACK

Waypoint	Type	Dsr'd	Trk	Distance	ETE
1 T005	<input checked="" type="checkbox"/>	---	°	---n	---m
2 T004	<input checked="" type="checkbox"/>	---	°	---n	---m
3 T003	<input checked="" type="checkbox"/>	---	°	---n	---m
4 T002	<input checked="" type="checkbox"/>	---	°	---n	---m
5 T001	<input checked="" type="checkbox"/>	---	°	---n	---m
6	<input type="checkbox"/>	---	°	---n	---m
7	<input type="checkbox"/>	---	°	---n	---m
8	<input type="checkbox"/>	---	°	---n	---m

Use cursor to review route

Routes Haypts Map Cfg Aux Delete

Start TracBack allows you to retrace your path using the track plot automatically stored in the receiver's memory. This eliminates the need to manually store waypoints along the way. A track plot is an electronic breadcrumb trail, showing the path you have travelled. Your GPSMAP can be set to automatically record track plot points any time the receiver is on and locked onto satellites (see page 59).

TracBack routes are created by reducing your track plot into a route of up to 50 waypoints and activating the new route in reverse order along those waypoints. Once activated, a TracBack route will lead you back to the oldest track plot point stored in memory, so it's a good idea to erase the track memory at the beginning of your current trip (e.g., at the dock), before you get started (see page 59).

To create and activate a TracBack route:

1. Enable track plot recording and leave the GPSMAP on to automatically record track log positions while underway (see page 59).
2. Select the Start TracBack option from the track recording submenu and press **ENT** to create/activate the TracBack route. (A message box will appear while the GPSMAP analyzes the data and creates the route.)

The TracBack route will contain waypoints (labeled 'T###', e.g. 'T001') which mark the most significant features of the original track plot in order to duplicate your path as closely as possible. To gain the most benefit from the TracBack feature, keep the following tips in mind:

- Always clear the track plot at the point you wish to return to (ramp, dock, etc.)
- The *Recording Status* must be set to 'Wrap' or 'Fill'.
- There must be at least two track plot points stored in memory to create a route.
- If the *Recording Interval* is set to 'Time' or 'Distance', the route may not closely follow your path. Use 'Resolution' for best results.
- If the receiver is turned off or satellite coverage is lost during your trip, TracBack will draw a straight line between any point where coverage was lost and where it resumed.

The last listing on the auxiliary options menu is the glossary function. The GPSMAP's on-screen glossary contains basic information on general navigation terms and abbreviations, as well as helpful hints on using your unit.

To use the on-screen glossary:

1. Highlight the Glossary option from the Auxiliary Options window and press the **ENT** key.
2. Use the PREV PG and NEXT PG softkeys to scroll through the glossary listings.

The Auxiliary Options window is also used to access any current messages in your unit. There are two types of messages used in the GPSMAP system: temporary messages (eg. approaching a waypoint) and condition messages (eg. no DGPS position). All message are initially indicated by a flashing on-screen alert (and a tone, if specified). After a temporary message has been acknowledged (by pressing the **ENT** key), it is cleared from the screen. Condition messages will remain displayed in the messages window until the condition has been resolved.

To view condition messages:

1. From the Auxiliary Options window, press the MESSAGE softkey.
2. To return to the Auxiliary Options window, press the **ENT** key.

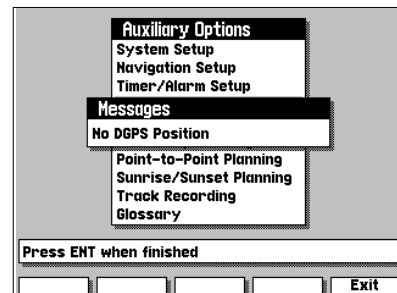
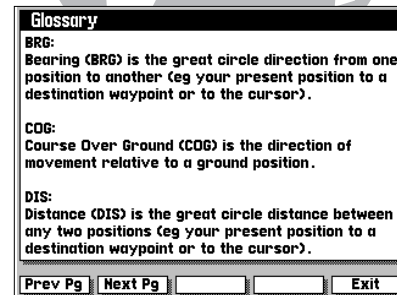

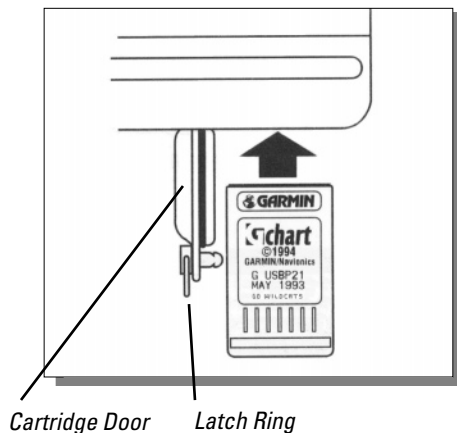

The GARMIN GPSMAP system uses G-chart™ digital cartography to display nautical charts on-screen. G-chart™ inland and offshore cartridges are installed in the card slot located at the bottom right of the GPSMAP unit. G-chart™ cartridges may be installed or removed at any time, whether the unit is on or off.

To install a G-chart™ cartridge:

1. Turn the latch ring 1/4 turn counterclockwise and open the cartridge door.
2. Insert the card (label facing front and G-chart™ logo at top) into the slot.
3. Use your thumb to firmly push the cartridge into place, until the cartridge will not go any further into the unit.
4. If your GPSMAP is on, a confirmation tone will sound when the cartridge has been properly installed and accepted.
5. Close the cover and turn the latch ring 1/4 turn clockwise to secure. The cartridge door features a sealing gasket to keep moisture out of the G-chart™ area.



If you insert a G-chart™ cartridge and get a 'card format not recognized' message, try removing the card and reinserting it. If the card is still not recognized, contact the dealer you purchased it from for assistance. G-chart™ cartridges are not waterproof, and should not be exposed to moisture or static discharges.

To remove a G-chart™ cartridge:

1. Turn the latch ring 1/4 turn counterclockwise and open the cartridge door.
2. Grasp the card at the bottom groove and pull firmly to remove.
3. If your GPSMAP is on, a confirmation tone will sound when the G-chart™ cartridge has been removed.

Once a G-chart cartridge has been inserted, the map coverage outlines for the cartridge will automatically appear on screen. Keep in mind that the display will not automatically scroll to the map area or zoom to a level where you can see the coverage outlines. If you do not immediately see the outlines, scroll the cursor to the broad geographic area covered by the chart and/or zoom out to another map scale. You may have to press the **MAPS** key to display the outlines.

The large outline box shown is the main chart, which serves as the boundary area for the entire cartridge. The smaller boxes inside the main box are subcharts, which provide more detailed coverage of the area indicated. To view the detailed cartography of any subchart, scroll the cursor to the subchart outline and use the **ZOOM** key to zoom in to smaller range scales.



Whenever you zoom past the usable range of the current electronic chart, the range field will display 'Ovr Zm' or 'No Map'. These warnings indicate that although you may still have cartography, you should exercise extreme caution using the data. See page 20 for more information on Overzoom and No Map modes.

When a G-chart cartridge is installed, the GPSMAP system will automatically use the best available chart for display. As you enter and exit various subcharts, the system will automatically display the appropriate chart for the area you are in. When you leave the area covered by the main map of a cartridge, the GPSMAP will default back to using the built-in worldwide database if it is available at the current scale. Once you've inserted a cartridge, the coverage outlines can be turned off to keep the display as uncluttered as possible.

To turn the map outlines on or off:

1. Press the **MAPS** key.

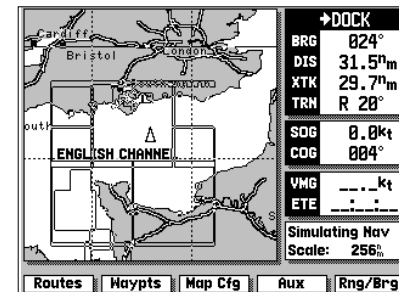
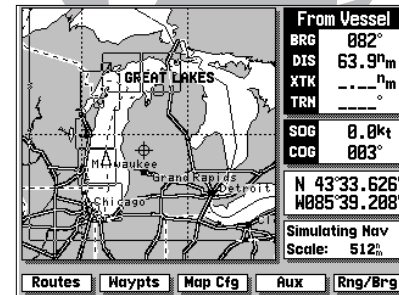

SECTION 10 G-CHART CARTRIDGES

Port Services Information

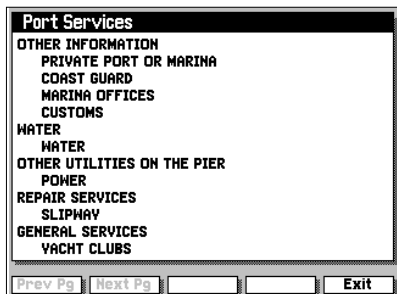
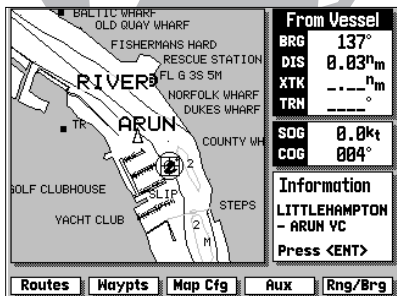

Port Services Information Icons

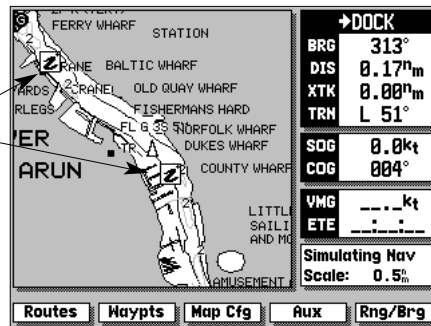

Some G-chart™ cartridges include port services information, which lists available services and facilities for the selected area. When this information is available, a port services 'information' icon will appear on the map display (typically at lower scale settings only).

To view port services information:

1. Use the **ENT** keypad to place the panning cursor on a port services information icon. Once the icon is selected, an information box appears (at lower right corner of the screen) showing the name of the selected port.
2. Press **ENT** to display the full listing of available services.
3. Use the NEXT PG and PREV PG softkeys to view additional pages of information.



At this writing, port services information is available on many G-chart™ cartridges throughout Europe, with plans underway to expand this coverage worldwide.

Your GPSMAP system includes the following hardware components:

- GPSMAP Unit
- Gimbal Mount Bracket (with knobs)
- GPS Antenna with 30' cable
- Power/Data Cable
- 2-amp in-line fuse (included with Power/Data cable)
- Antenna Combiner (for GPSMAP purchased with built-in DGPS)
- Antenna Coupler and Whip Antenna (for GPSMAP purchased with built-in DGPS)

If you are missing any of the above pieces, see your dealer. To complete the standard installation, you'll also need the following additional:

- Four 1/4" (6 mm) diameter mounting screws
- 1" x 14 thread antenna mounts (Two for GPSMAP with built-in DGPS)

Several optional accessories are also available to provide flexible installation on any vessel. See your GARMIN dealer for more information on these items:

- GA23 H-Field antenna.
- Flush Mount Kit
- 30' Antenna Cable Extension
- 110/220 volt AC adapter
- Cigarette Lighter Adapter



Reading through the entire installation section before starting your installation will help you get the most out of your GARMIN navigation system. An improper or poorly planned installation can affect the GPS receiver's accuracy, overall performance and your ability to satisfactorily use the GPSMAP system.



WARNING!

*The GPSMAP system has no user-serviceable parts, and you should never attempt any repairs yourself. The unit is gasket-sealed to prevent moisture penetration. Opening the case or loosening any fittings may expose internal components to moisture and **will void the manufacturer's warranty!***

For warranty and service details, see page iii at the front of this manual.

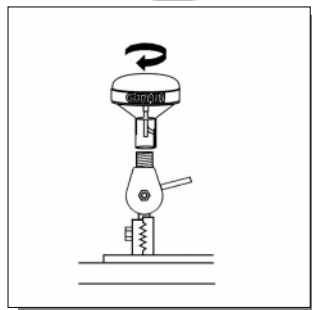
**CAUTION!**

Cutting or modifying the antenna(s) may result in undesired operation of the GPS. If the standard cable is not long enough for your application, see your dealer for the proper GARMIN cable extension. When in doubt, seek the assistance of a qualified installation technician.

To begin installation, you'll need to select a suitable mounting position for the antenna(s) and the GPSMAP unit. Once you've identified the best mounting locations for your application, install the antenna(s) and its cable(s) first, then the unit and power/data cable.

Mounting the antenna(s)

The GPS antenna should be mounted in a location that has a clear, unobstructed view of the sky in all directions to ensure the best reception in all conditions. Avoid mounting the antenna where it will be shaded by the boat's superstructure, a radome antenna, or mast.

The beacon antenna provides more flexibility in mounting locations. Mounting near objects which partially shade its field of view is not a critical concern, however large metal objects may create enough obstruction to degrade reception and performance. As a general rule, mount the antenna at least 3 feet from all other antennas and the vessel's alternator/ignition system components. A ground strap is attached to the antenna coupler, except on the GA 23 H-field antenna. *For proper operation, the ground strap must be connected to a vessel (earth) ground. Do not ground the coupler to the electrical system.*

GARMIN antennas screw directly onto any standard 1" x 14 thread antenna mount. If you need to raise an antenna to avoid shading, try using a 1" x 14 thread extension mast available at most marine dealers.

To install the antenna(s):

1. Screw the antenna directly onto the 1" x 14 thread mount.
2. Route the cable to the mounting location of the display unit, using the appropriate tie-wraps, escutcheon plates and sealant to secure the cable along the route and through any bulkhead or deck.
3. Once the GPSMAP unit has been installed, connect the cable to the antenna connector on the back of the unit. Make sure that you turn the antenna 1/4 turn clockwise to lock the cable into place. (For models purchased with built-in DGPS, connect each antenna cable to the Antenna Combiner. Then use the supplied short cable to connect the Antenna Combiner to the back of the unit.)

Antenna connection for GPSMAP system with built-in DGPS

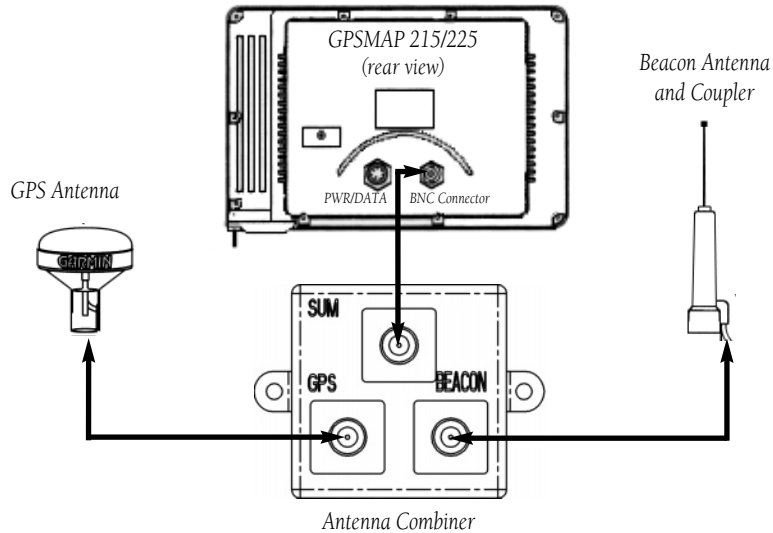

Antenna connection for GPSMAP system without built-in DGPS:

GPSMAP systems without the built-in DGPS beacon receiver do not include the antenna combiner and antenna coupler. The GPS antenna is connected directly to the BNC connector on the back of the unit. DGPS capability can be added, as an option, by purchasing an external beacon receiver—such as GARMIN's GBR 21/23.

Connections to an external beacon receiver are made using the NMEA IN, NMEA OUT (for GBR 21/23 only) and GROUND connections on the supplied power/data cable. See the beacon receiver owner's manual for connection information not covered in the above diagram.

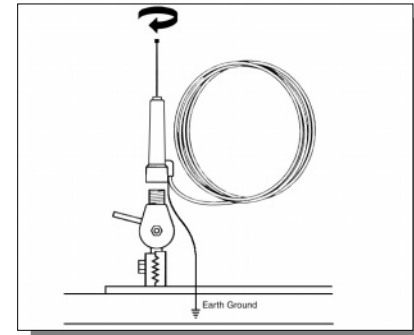

A second 1" x 14 thread antenna mount is needed when installing a GPSMAP with built-in DGPS beacon receiver. The second mount is used for the antenna coupler and whip antenna. Connect the antenna coupler's ground strap to a vessel (earth) ground. An earth ground connection can usually be made by connecting to a thru-hull fitting, engine block, dynaplate or body of a metal vehicle.

Note: The GA 23 H-field antenna does not require grounding.

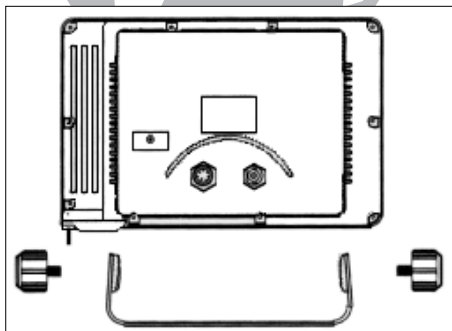
**WARNING!**

The temperature range for GPSMAP units is from -4 to +158°F (-20- 70°C). Extended exposure to temperatures exceeding this range (in storage or operating conditions) may cause failure of the LCD screen. This type of failure and related consequences ARE NOT covered by the manufacturer's warranty.

Mounting the GPSMAP unit

The GARMIN GPSMAP's fully gasketed and sealed case is suitable for mounting in exposed locations or at the nav station. The unit comes with a gimbal bracket that can be used for surface or overhead mounting. When choosing a location for the display unit, make sure you consider the following conditions:

- There should be at least 3.25" (8.25 cm) clearance behind the case to allow connection of the antenna and power/data cables.
- Provide adequate clearance for the G-chart cartridge cover to swing open freely. You may swivel the unit to get a firm grip on the cartridge.
- The mounting surface should be heavy enough to support the unit and protect it from excessive vibration and shock.
- The GPSMAP 215 screen will provide crisp contrast in most lighting conditions, even in full sunlight. Because of the technology used in TFT screens, the GPSMAP 225 performs best in shaded conditions, protected from direct sunlight.

To install the GPSMAP unit:

1. Place the mounting bracket in the desired location.
2. Mark and drill the four mounting holes for the fasteners you are using.
3. Fasten the bracket to the surface using the appropriate fasteners.
4. Insert the GPSMAP into the mounting bracket. The bracket is designed for a tight fit to provide additional support when swiveling the unit.
5. Screw the two mounting knobs through the bracket and into the display case.
6. Connect the power/data and antenna cables to the back of the unit, making sure the locking rings are fully tightened on both connectors.

Connecting the power/data cable

The power/data cable connects the GPSMAP system to a 10-40 volt DC power source and provides interface capabilities for connecting NMEA devices, an external beacon receiver (if not equipped with built-in DGPS), and an external alarm (see section 9 for interface operation details). The color code in the diagram below indicates the appropriate harness connections.

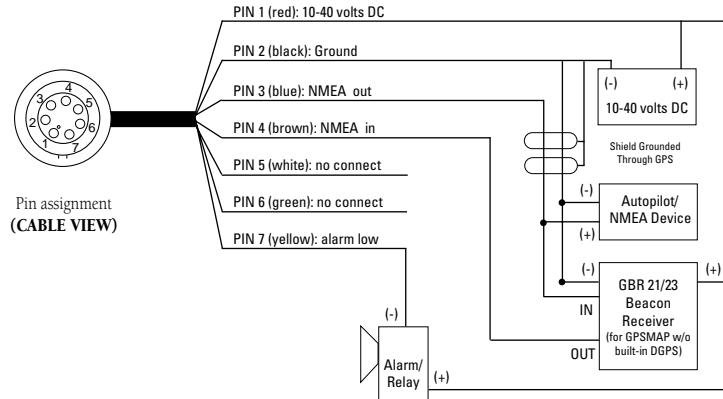

To connect the GPSMAP to a power source:

1. Connect the RED harness lead to the positive side of a 10-40 volt DC power source. Make sure the power lead has an in-line 2-amp fuse installed.
2. Connect the BLACK harness lead to a ground strip or the negative side of a 10-40 volt DC power source.

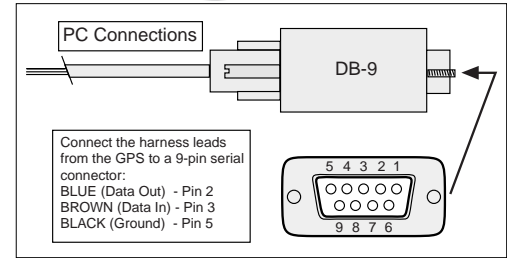

The GPSMAP system will interface to RS-232 devices using NMEA data, to an external alarm device, and to a PC (see PC connection info above).

To connect to an NMEA device, use the BLUE (out) and BLACK (ground) harness leads. Some devices will support bi-directional data exchange. For those devices you must also use the BROWN (in) lead.

To connect an external alarm (100 mA max. coil current), connect the ground side of the alarm device or relay to the YELLOW harness lead.

Complete information concerning NMEA formats and sentences is available for purchase from NMEA at:

NMEA

PO Box 3435
New Bern, NC 28564-3435
252-638-2626
252-638-4885 FAX.

The following interface formats are supported by the GPSMAP system for connection to up to three NMEA devices (GPSMAP units with built-in DPGS do not support RTCM DGPS corrections data inputs or the PSLIB beacon receiver control sentence output):

NMEA 0180

NMEA 0182

NMEA 0183 version 1.5

Approved sentences—

GPBWC, GPGLL, GPRMB,
GPRMC, GPXTE, GPVTG, GPWPL

Proprietary sentences—

PGRMM (map datum), PGRMZ (altitude),
PSLIB (beacon receiver control input)

NMEA 0183 version 2.0

Approved sentences—

GPGGA, GPGSA, GPGSV, GPRMB, GPRMC, GPRTE, GPWPL

Proprietary sentences—

PGRME (estimated error), PGRMM (map datum)
PGRMZ (altitude), PSLIB (beacon receiver control input)

DGPS corrections are accepted in RTCM-104 v. 2.0 format through the NMEA in (BROWN) harness lead. The GARMIN GBR 21 or GBR 23 are the recommended beacon receivers for use with the GPSMAP system. Other receivers with the correct RTCM format may be used, but may not correctly display DGPS status on the GPSMAP display or allow tuning control from the GPSMAP unit.

GPSMAP Specifications**PHYSICAL**

Case:	Fully gasketed, high-impact plastic alloy
Size:	5.8"H x 9"W x 3"D (14.7 x 22.9 x 7.6 cm)
Weight:	Less than 3 lbs. (1.4 kg)
Temperature Range:	-4° to 158°F (-20° to 70°C)

PERFORMANCE

Receiver:	Differential-ready 12 parallel channel
Acquisition Time:	Approx. 15 seconds (warm) Approx. 45 seconds (cold) Approx. 5 minutes (AutoLocate™)
Update Rate:	1/second, continuous
Position Accuracy:	1-5 meters (3-15 ft.) with DGPS corrections* 15 meters (49 ft.) RMS**
Velocity Accuracy:	0.1 knot RMS steady state
Dynamics:	6g's

POWER

Input:	10-40vDC
Usage:	15 watts max. / 9 watts typical (215) 25 watts max. / 13 watts typical (225)

Specifications subject to change without notice.

** With built-in DGPS beacon receiver or external GARMIN GBR 21 or GBR 23 Beacon Receiver Input.*

*** Subject to accuracy degradation to 100m 2DRMS under the United States Department of Defense-imposed Selective Availability Program.*

The GPSMAP system uses an on-screen message field to alert you to important information. Whenever a message appears, press the **ENT** key to confirm the message.

There are two types of messages: temporary messages and condition messages. Temporary messages are cleared from the message page after viewing, while condition messages remain in the message window until the condition has been resolved.

To view the message window, press the **MESSAGES** softkey from the Auxiliary Options Window. Pay careful attention to all messages for your own safety.

Alarm Clock—The alarm clock time has been reached and the alarm has sounded.

Anchor Drag Alarm—You have drifted out of the specified distance range.

Antenna Input Shorted to Ground—The GPSMAP has detected a short on the antenna connection. Check the connection, combiner (if used) and cable(s). Modifying cables (shortening or changing connectors) can also cause this condition if done improperly and may void your warranty.

Approaching—You are less than one minute away from reaching a destination waypoint at your present speed over ground.

Arrival At—You are within the distance specified on the timer/alarm setup from reaching your final destination waypoint.

Can't Change Active Waypoint—You have attempted to change the 'active to' or 'active from' waypoint. Clear the active route or GOTO before making your changes.

Card Format Not Recognized—The cartridge you have inserted is not readable by the GPSMAP system and may be damaged. Reinsert the cartridge and make sure it is properly installed.

Database Memory Failed—The built-in 64 n.m. database has failed. See an authorized service center for repair.

Degraded Accuracy—The accuracy of the GPSMAP has been degraded beyond 500 meters due to poor satellite geometry or data quality. You should check other navigational sources to verify the position indicated.

Display ROM Failed—The graphic processor read-only memory has failed and the unit is no longer operable. See an authorized GARMIN service center for repair.

Max Calibration Is 5000mt (16,400 ft)—You have exceeded the maximum possible map calibration.

Memory Battery Low—The internal lithium battery that maintains waypoint, route and track plot memory (when the unit is off) needs to be replaced. Take your unit to an authorized GARMIN service center for installation of a new battery.

No DGPS Position—Not enough data is being received to compute a DGPS position or unit has lost DGPS signal. Make sure the antenna coupler is properly grounded (see Appendix A-Installation) and the correct frequency and bit rate are selected on the Interface Setup page.

Off Course Alarm—You have exceeded the off-course distance (left or right) specified in the timer/alarm setup.

Oscillator Needs Adjustment—The GPSMAP has detected excessive drift in its internal oscillator which may result in longer acquisition times. Take your unit to an authorized GARMIN service center for adjustment.

Poor GPS Coverage—The GPSMAP cannot acquire the necessary number of satellites to compute a position.

Power Down and Re-init—The GPSMAP cannot calculate a position due to abnormal satellite conditions. Power down and verify the last position shown by other means.

Proximity Alarm—You have entered the alarm radius specified for the proximity waypoint indicated.

Proximity Overlap—The alarm radius specified overlaps the area specified for another proximity waypoint. See section 9 for more information on proximity overlaps.

RAM Failed—The random access memory has failed and the unit is not operable. Take your unit to an authorized GARMIN service center for repairs.

ROM Failed—The permanent memory has failed and the unit is not operable. Take your unit to an authorized GARMIN service center for repairs.

GPSMAP Units with Built-in DGPS

A DGPS beacon receiver is contained within the GPSMAP package. No interface connections are required other than connection of antenna combiner and antennas.

Received Invalid Waypoint—A waypoint was received during upload transfer that has an invalid identifier.

Receiver Failed—A failure in receiver hardware has been detected. If this message persists, do not use the unit and take it to an authorized dealer for repair.

Route is Full—You have attempted to add more than 50 waypoints to a route.

Route Waypoint Deleted—A route waypoint entered does not exist in the database and has been deleted from the route.

Searching the Sky—The GPSMAP is in searching the sky for almanac data or the unit is in AutoLocate™ mode.

Stored Data Lost—All waypoints, routes and almanac data has been lost due to internal battery failure.

Timer Expired—The countdown timer has expired.

Track Memory Full—The track memory is full and no additional track plot will be recorded until the track memory has been cleared or set to wrap mode (see page 59).

Transfer Completed—The receiver is finished uploading or downloading information to the connected device.

User Card Operation Complete—The user card data transfer has been completed.

Waypoint Exists—The waypoint name you're entering already exists in memory.

Waypoint Memory Full—You have used all available waypoints in the GPSMAP unit.

The chart below gives an approximate UTC(Universal Time Coordinate) time offset for the various longitudinal zones. Check with local charts for more detailed information. If you are in daylight savings time, add one hour to the offset.

Longitudinal Zone	Offset
W180.0° to W172.5°	-12
W172.5° to W157.5°	-11
W157.5° to W142.5°	-10
W142.5° to W127.5°	-9
W127.5° to W112.5°	-8
W112.5° to W097.5°	-7
W097.5° to W082.5°	-6
W082.5° to W067.5°	-5
W067.5° to W052.5°	-4
W052.5° to W037.5°	-3
W037.5° to W022.5°	-2
W022.5° to W007.5°	-1
W007.5° to E007.5°	0
E007.5° to E022.5°	+1
E022.5° to E037.5°	+2
E037.5° to E052.5°	+3
E052.5° to E067.5°	+4
E067.5° to E082.5°	+5
E082.5° to E097.5°	+6
E097.5° to E112.5°	+7
E112.5° to E127.5°	+8
E127.5° to E142.5°	+9
E142.5° to E157.5°	+10
E157.5° to E172.5°	+11
E172.5° to E180.0°	+12

A simple way to determine your local time offset is how many hours you are behind or ahead of UTC (also called 'Greenwich' or 'zulu' time).

Example: EST(Eastern Standard Time) is 5 hours behind UTC, so your offset would be -5. Adding one hour for daylight savings would make EDT(Eastern Daylight Time) -4. Subtract an hour for each time zone as you travel west.

Offsets for Continental U.S. would be:

EST	-5	EDT	-4
CST	-6	CDT	-5
MST	-7	MDT	-6
PST	-8	PDT	-7

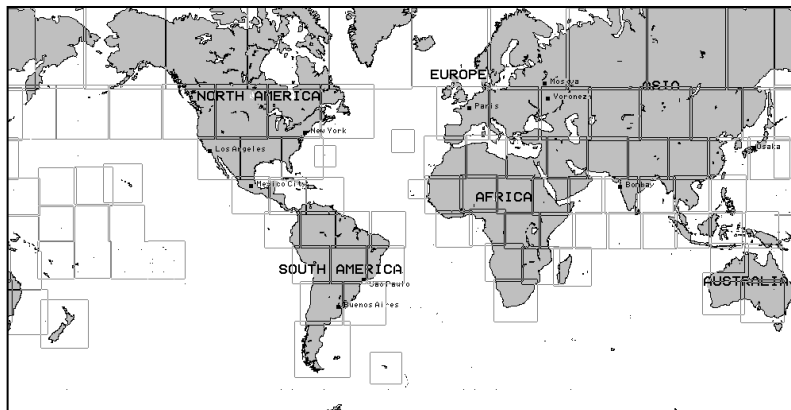

The GPSMAP's built-in world-wide database includes chart coverage down to 64 n.m. (120 km) for the areas outlined above. Note that the GPSMAP database is only valid to 68°15' of latitude. The maximum cursor latitude is 85°05', and the maximum waypoint latitude is 89°24.543 north or south.

Adindan	Adindan- Ethiopia, Mali, Senegal, Sudan	Astr Stn '52	Astronomic Stn '52- Marcus Island
Afgooye	Afgooye- Somalia	Astrln Geod '66	Australian Geod '66- Australia, Tasmania Island
AIN EL ABD '70	AIN EL ANBD 1970- Bahrain Island, Saudi Arabia	Austria	Austria
Anna 1 Ast '65	Anna 1 Astro '65- Cocos I.	Astrln Geod '84	Australian Geod '84- Australia, Tasmania Island
ARC 1950	ARC 1950- Botswana, Lesotho, Malawi, Swaziland, Zaire, Zambia, Zimbabwe	Bellevue (IGN)	Efate and Erromango Islands
ARC 1960	Kenya, Tanzania	Bermuda 1957	Bermuda 1957- Bermuda Islands
Ascnsn Isld '58	Ascension Island '58- Ascension Island	Bogata Observ	Bogata Observatry- Colombia
Astro B4 Sorol	Sorol Atoll- Tern Island	Campo Inchspe	Campo Inchauspe- Argentina
Astro Bcn "E"	Astro Beacon "E"- Iwo Jima	Canton Ast '66	Canton Astro 1966- Phoenix Islands
Astro Dos 71/4	Astro Dos 71/4- St. Helena		

Cape	Cape- South Africa	Indian Thailand	Indian- Thailand, Vietnam
Cape Canavrl	Cape Canaveral- Florida, Bahama Islands	Indonesia 74	Indonesia 1974-Indonesia
Carthage	Carthage- Tunisia	Ireland 1965	Ireland 1965- Ireland
CH-1903	CH 1903- Switzerland	ISTS 073 Astro	ISTS 073 ASTRO '69- Diego Garcia
Chatham 1971	Chatham 1971- Chatham Island (New Zealand)	Johnston Island	Johnston Island
Chua Astro	Chua Astro- Paraguay	Kandawala	Kandawala- Sri Lanka
Corrego Alegre	Corrego Alegre- Brazil	Kerguelen Islnd	Kerguelen Island
Djakarta	Djakarta (Batavia)- Sumatra Island (Indonesia)	Kertau 1948	West Malaysia, Singapore
Dos 1968	Dos 1968- Gizo Island (New Georgia Islands)	L. C. 5 Astro	Cayman Brac Island
Easter Isld 67	Easter Island 1967	Liberia 1964	Liberia 1964- Liberia
European 1950	European 1950- Austria, Belgium, Denmark, Finland, France, Germany, Gibraltar, Greece, Italy, Luxembourg, Netherlands, Norway, Portugal, Spain, Sweden, Switzerland	Luzon Mindanao	Luzon- Mindanao Island
European 1979	European 1979- Austria, Finland, Netherlands, Norway, Spain, Sweden, Switzerland	Luzon Philippine	Luzon- Philippines (excluding Mindanao Isl.)
Finland Hayfrd	Finland Hayford- Finland	Mahe 1971	Mahe 1971- Mahe Island
Gandajika Base	Gandajika Base- Republic of Maldives	Marco Astro	Marco Astro- Salvage Isl.
Geod Datm '49	Geodetic Datum '49- New Zealand	Massawa	Massawa- Eritrea (Ethiopia)
Guam 1963	Guam 1963- Guam Island	Merchich	Merchich- Morocco
Gux I Astro	Guadalcanal Island	Midway Ast '61	Midway Astro '61- Midway
Hjorsey 1955	Hjorsey 1955- Iceland	Minna	Minna- Nigeria
Hong Kong '63	Hong Kong	NAD27 Alaska	North American 1927- Alaska
Hu-Tzu-Shan	Taiwan	NAD27 Bahamas	North American 1927- Bahamas (excluding San Salvador Island)
Indian Bngldsh	Indian- Bangladesh, India, Nepal	NAD27 Canada	North American 1927- Canada and Newfoundland
		NAD27 Canal Zone	North Am. 1927- Canal Zone
		NAD27 Caribbn	North American 1927- Caribbean (Barbados, Caicos Islands, Cuba, Dom. Rep., Grd. Cayman, Jamaica, Leeward and Turks Islands)
		NAD27 Central	North American 1927-

Central America (Belize, Costa Rica, El Salvador, Guatemala, Honduras, Nicaragua)

NAD27 CONUS North Am. 1927- Mean Value (CONUS)

NAD27 Cuba North American 1927- Cuba

NAD27 Grnland North American 1927- Greenland (Hayes Peninsula)

NAD27 Mexico N. American 1927- Mexico

NAD27 San Sal North American 1927- San Salvador Island

NAD83 North American 1983- Alaska, Canada, Central America, CONUS, Mexico

Nhrwn Masirah Nahrwn- Masirah Island (Oman)

Nhrwn Saudi A Nahrwn- Saudi Arabia

Nhrwn United A Nahrwn- United Arab Emirates

Naparima BWI Naparima BWI- Trinidad and Tobago

Obsrvtorio '66 Observatorio 1966- Corvo and Flores Islands (Azores)

Old Egyptian Old Egyptian- Egypt

Old Hawaiian Old Hawaiian- Mean Value

Oman Oman- Oman

Ord Srvy GB Old Survey Grt Britn- England, Isle of Man, Scotland, Shetland Isl., Wales

Pico De Las Nv Canary Islands

Potsdam Potsdam-Germany

Ptcairn Ast '67 Pitcairn Astro '67- Pitcairn

Prov S Am '56 Prov So Amrcn '56- Bolivia, Chile, Colombia, Ecuador, Guyana, Peru, Venezuela

Prov S Chln '63

Puerto Rico

Qatar National

Qornoq

Reunion

Rome 1940

RT 90

Santo (Dos)

Sao Braz

Sapper Hill '43

Schwarzeck

Sth Amrcn '69

South Asia

SE Base

SW Base

Timbalai 1948

Tokyo

Tristan Ast '68

Viti Levu 1916

Wake-Eniwetok

WGS 72

WGS 84

Zanderij

So Chilean '63- S. Chile

Puerto Rico & Virgin Isl.

Qatar National- Qatar

Qornoq- South Greenland

Reunion- Mascarene Island

Rome 1940- Sardinia Isl.

Sweden

Santo (Dos)- Espirito Santo

Sao Braz- Sao Miguel,

Santa Maria Islands

Sapper Hill 1943- East

Falkland Island

Schwarzeck- Namibia

S. American '69- Argentina,

Bolivia, Brazil, Chile,

Colombia, Ecuador,

Guyana, Paraguay, Peru,

Venezuela, Trin/Tobago

South Asia- Singapore

Southeast Base- Porto

Santo and Madiera Islands

Southwest Base- Faial,

Graciosa, Pico, Sao Jorge

and Terceira Islands

Timbalai 1948- Brunei and

E. Malaysia (Sarawak and

Sabah)

Tokyo- Japan, Korea,

Okinawa

Tristan Astro 1968- Tristan

da Cunha

Viti Levu 1916- Viti Levu/

Fiji Islands

Wake-Eniwetok- Marshall

World Geodetic System 72

World Geodetic System 84

Zanderij- Surinam

Almanac Data—Satellite constellation information (including location and health of satellites) that is transmitted to your receiver from every GPS satellite. Almanac data must be acquired before GPS navigation can begin.

Bearing—The compass direction from your position to a destination.

Course Over Ground (COG)—Direction of movement relative to a ground position.

Crosstrack Error (XTK)—The distance you are off a desired course in either direction.

Desired Track (DTK)—The compass course between the ‘from’ and ‘to’ waypoints.

Differential GPS (DGPS)—An extension of the GPS system that uses land-based radio beacons to transmit position corrections to GPS receivers.

Estimated Time of Arrival (ETA)—The time of day of your arrival at a destination.

Estimated Time Enroute (ETE)—The time left to your destination at your present speed.

Grid—A coordinate system that projects the earth on a flat surface, using square zones for position measurements.

Ground Speed—The velocity you are travelling relative to a ground position.

Latitude—A north/south measurement of position perpendicular to the earth’s polar axis.

Longitude—An east/west measurement of position in relation to the Prime Meridian, an imaginary circle that passes through the north and south poles.

Position—An exact, unique location based on a geographic coordinate system.



Turn (TRN)— The difference and direction in degrees between the bearing to your destination and your course over ground. The TRN value is used to indicate what direction and how many degrees to turn to get back on course.

Universal Time Coordinated (UTC)— The time of day at the prime meridian (0° longitude) in Greenwich, England.

Universal Transverse Mercator- (UTM)— A grid coordinate system that projects global sections onto a flat surface to measure position in specific zones.

Velocity Made Good (VMG)—The speed you are closing in on a destination along a desired course.

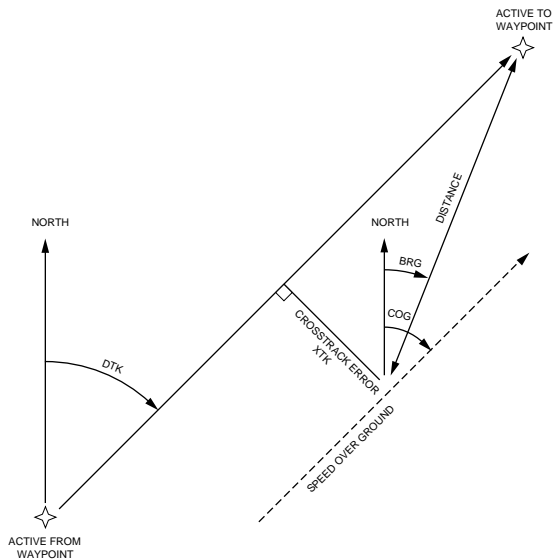

Loran TD System

LORAN C is a radio navigation aid operated and maintained in the United States by the United States Coast Guard. The name LORAN is an acronym for "LONG RAnge Navigation". The LORAN system covers the entire United States and the U.S. Coastal Confluence Zone. From the perspective of a mariner, the system is used for ocean and coastal navigation. It can be used as a supplemental system for harbor and harbor approach navigation, and it is used for inland navigation by recreational vehicles.

LORAN TD Feature

The LORAN TD(Time Delay) feature eases the transition from using LORAN to using GPS. The GPSMAP unit automatically converts GPS coordinates to LORAN TDs for those who have a collection of LORAN fixes for favorite fishing spots and other waypoints recorded as TDs. You can display your position as a TD or enter waypoints as TDs. The accuracy to be expected from this conversion is approximately thirty meters. When the unit is placed in the LORAN TD format mode, it *simulates* the operation of a LORAN receiver. Position coordinates may be displayed as TDs, and all navigation functions may be used *as if* the unit were actually receiving LORAN signals.

Using the LORAN TD Format

When creating new waypoints using LORAN TD coordinates you must set the correct LORAN chain number and secondary stations in the Setup TD field before storing the waypoint. After the waypoint is stored in unit memory, it will always reference the LORAN chain number and secondary stations currently selected in the Setup TD field. If you enter a different LORAN chain number, change the secondary stations or offsets in the Setup TD field, the active waypoint

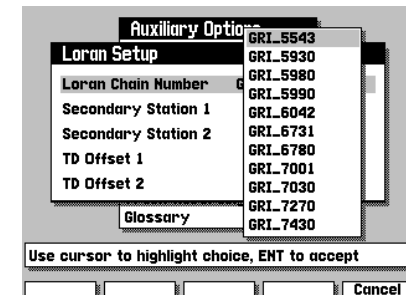
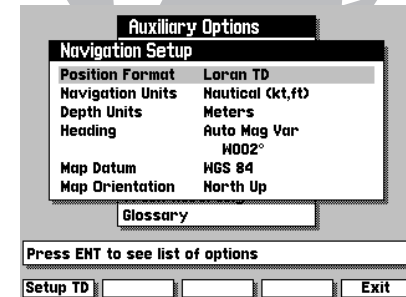

SECTION H

APPENDIX

Loran TDs

Auxiliary Options

Loran Setup

Loran Chain Number GRI_5543

Secondary Station 1 Y

Secondary Station 2 Y

TD Offset 1 X

TD Offset 2 Y

Glossary

Use cursor to highlight choice, ENT to accept

Cancel

Auxiliary Options

Loran Setup

Loran Chain Number GRI_5543

Secondary Station 1 W

Secondary Station 2

TD Offset 1 Enter Number

TD Offset 2

Glossary

Use cursor & ENT to select

Use cursor to highlight choice, ENT to accept

Bkspc Clear Restore OK Cancel

information will reflect those changes. Since the GPSMAP unit does not rely on the LORAN signal for navigation, it can reference a different GRI chain and/or secondary stations and still navigate to the location stored in memory.

The LORAN Position Format field is located in the Navigation Setup Menu. After the 'LORAN TD' format is selected, a new option will appear over the key called 'Setup TD'. The 'LORAN Setup' page contains the fields where the LORAN GRI-Chain Number, Primary & Secondary Stations and TD Offsets are selected.

To change the “Setup TD” settings:

1. Press the under SETUP TD.
2. Use the key to select the field to change and press **ENT**.
3. Use the key to highlight the new setting and press **ENT**.
4. When done, press the key under the word EXIT to exit.



If the active GRI Chain, secondary stations or offsets have been changed since the waypoint was created, the waypoint will now reference the active GRI-chain and secondary stations and the TD coordinates will be adjusted accordingly. Remember that the GPS is not relying on the LORAN signal for navigation and actually converts the TD coordinate to a useful LAT/LON coordinate (in the background) before storing the waypoint in unit memory or using it for navigation. Because of this the unit can navigate to a TD coordinate anywhere in the world.

A		Cross Track Error	79
Activating Routes	39	CTR Key	viii, 6, 19
Active Route	11, 27, 37	Cursor Mode	18
Active Route Page	11, 27	Cursor Movement	6, 19
Active Waypoints	25, 27, 37		
Alarm Setup	51	D	
Anchor Alarm	51	Data Entry	3, 47
Antenna Installation	66-67	DATA Key	viii, 4, 10-11, 22, 25
Arrival Alarm	51	Data Window	4, 21
Auxiliary Menu	2, 46-61	Date/Time Formats	48
		Datums	50, 76-78
B		Definitions	59, 79-80
Backlight Level	1	Desired Track (DTK)	79
Beacon Receiver Setup	52-54, 67	Depth Contours	23-24, 49
Beacon Status	15-16	Depth Units	49
Bearing	79	Deleting Routes	39
Bearing Pointer	26	Deleting Waypoints	30-31
Boat Icon	17	DGPS Setup	52-54, 67
Boat Mode	18	DGPS Status	15-16
Built-in Map Coverage	76		
		E	
C		Editing Routes by Text	43-44
Calibrations, Map	24	Editing Routes Graphically	40-42
Cancelling Active Routes	39	Editing Waypoints by Text	31
Cancelling Active GOTOs	36	Editing Waypoints Graphically	29-30
Capabilities	vii	Elapsed Timer	51
Cautions	ii	ENT Key	viii, 3, 46-47
Clock Alarm	51	Entering Initial Position	16
Configurations, GPSMAP Unit	46-61	Estimated Time of Arrival (ETA)	79
Configurations, Map	23-24	Estimated Time Enroute (ETE)	79
Contrast Setting	48		
Countdown/Elapsed Timers	51	F	
Creating Routes	38, 45	Full Screen Mapping	22
Creating Waypoints	28, 32		



INDEX

G			
G-chart Cartridges.....	62-64	Map Datum Selection	50
Glossary	59, 79-80	Map Display	4
GOTO Key	viii, 12, 35-36	Map Orientation	50
Grid Coordinates	49	Map Page.....	17-24
Ground Speed.....	79	Map Scales.....	20
		MAPS Key.....	viii, 11, 63
H		Marine Data	23
Heading Selection.....	49	MARK Key	viii, 7, 34
Highway Page.....	25-26	Marking Positions	7, 34
Highway Scale	26	MENU Key	viii, 4, 22
		Menu Options	46-47
I		Menu Selection.....	46-47
Installation	65-69	Messages.....	12, 61
Interface Formats.....	80	Message Descriptions	72-74
Interface Setup	52-55	MOB Key	viii, 36
Interval, track storage	59	Modifying Routes	40-44
Inverting Routes	39	Modifying Waypoints.....	29-30
		Moving Waypoints	30, 40
K			
Keypad Usage	viii	N	
Keypad Tone	48	Navigation Setup	49
		Navigation Units.....	49
L		Nearest Waypoint List	33
Land Data	23	NMEA Formats.....	70
Local Time Offset	48	NMEA Setup	54-55
LORAN TDs	49, 81-82	No Map Mode	11, 20
		Normal Mode	48
M			
Magnetic Variation.....	49	O	
Man Overboard Function (MOB).....	36	Off Course Alarm	51
Map Calibration.....	24	Offset, local time	48, 73
Map Configuration	23-24	Operation Setup	48
Map Datum List	76-78	Overzoom Mode.....	11, 20

P		Sky View (Satellite).....15
Packing Listiv		Softkeys2
PAGE Keyviii		Softkey Menu5, 22
Physical Specifications71		Satellite Status Page2, 15-16
Point-to-Point Planning58		Sunrise/Sunset Calculation58
Port Services Information64		
Position Entry3, 16	T	Target Cursor6, 18
Position Format49		Text Entry3, 47
Power/Data Cable69		Time Offsets48, 75
Power Offviii, 13		Timer/Alarm Setup51
Power Onviii, 1		Tone Selection48
Proximity Alarm51		TracBack Routes58
Proximity Waypoints List56		Track Memory59
		Track Plot59
R		Track Recording59
Range/Bearing Calculations22		Turn (TRN)80
Reference Waypoints33	U	
Removing G-chart Cartridges62		Units of Measure49
Removing Route Waypoints42, 44		UTC time48
Removing Waypoints30-31		UTM/UPS Coordinates49, 80
Renaming Waypoints29, 44	V	
Resolution, Track Plot59		Velocity Made Good (VMG)80
Reviewing Routes40, 43, 45	W	
Reviewing Waypoints29		Warranty & Registrationiii
Routes8, 37-45		Waypoints28-33
Route Comments42		Waypoints List30-31
Route Planning Mode57		Waypoints, Nearest33
		Wiring Installation67, 69
S	Z	
Satellite Acquisition15, 16		ZOOM Keyviii, 20, 26
Signal Strength Bars15		
Simulator Mode2, 48		
Simulator Tour1-13		



© 1998-2000 GARMIN Corporation

1200 E. 151st Street, Olathe, KS 66062 U.S.A.

Web Site Address: www.garmin.com

GARMIN (Europe) Ltd., Unit 5, The Quadrangle, Abbey Park, Romsey, Hampshire SO51 9AQ U.K.

Garmin (Asia) Corp., No. 68, Jangshu 2nd Rd., Shijr, Taipei County, Taiwan

Part Number 190-00061-20 Rev. B